





Komínová rúra plastová biela - zvýhodnená cena balenia					
Kód	DN	Dĺžka (mm)	Ks	Cena za ks €	Cena balíka €
19060	60	2000	1	10,20	-
19060	60	2000	10	8,10	81,00
19080	80	2000	1	12,80	-
19080	80	2000	8	10,50	84,00
22060	60	1000	1	5,90	-
22060	60	1000	10	4,90	49,00
22080	80	1000	1	7,30	-
22080	80	1000	8	6,20	49,60



Komínová rúra plastová čierna - zvýhodnená cena balenia					
Kód	DN	Dĺžka (mm)	Ks	Cena za ks €	Cena balíka €
19060C	60	2000	1	8,90	-
19060C	60	2000	10	8,10	81,00
19080C	80	2000	1	12,80	-
19080C	80	2000	8	10,50	84,00
22060C	60	1000	1	5,90	-
22060C	60	1000	10	4,90	49,00
22080C	80	1000	1	7,30	-
22080C	80	1000	8	6,20	49,60

Vystreďovacia objímka UNI	Kód	Ks	Cena za ks €	Cena balíka €
	M3760200	1	2,90	-
	M3760200	4	2,22	8,88

Vystreďovacia objímka jednoduchá	Kód	Ks	Cena za ks €	Cena balíka €
	37060	1	3,20	-
	37060	10	3,00	30,00
	37080	1	3,40	-
	37080	10	3,20	32,00

PLASTOVÝ SYSTÉM PP

ABC PLYN

Rúra	L (mm)	Kód	Ø (mm)	€
	2000	19060	60	10,20
	2000	19080	80	12,80
	2000	19100	100	15,90
	2000	19110	110	15,30
	2000	19125	125	23,20
	2000	19160	160	35,50
	2000	19200	200	92,00
	1000	22060	60	5,90
	1000	22080	80	7,30
	1000	22100	100	9,40
	1000	22110	110	9,70
	1000	22125	125	13,50
	1000	22160	160	21,00
	1000	22200	200	63,00
	500	21060	60	4,10
	500	21080	80	5,50
	500	21100	100	5,90
	500	21110	110	6,10
	500	21125	125	6,70
	500	21160	160	12,60
500	21200	200	47,00	
250	20060	60	4,00	
250	20080	80	3,50	
250	20100	100	4,20	
250	20110	110	4,40	
250	20125	125	5,60	
250	20160	160	11,80	
250	20200	200	29,00	

Koleno 87°	Kód	DN	€
	10060	60	5,00
	10080	80	3,70
	10100	100	6,60
	10110	110	6,60
	10125	125	11,80
	10160	160	16,10
	10200	200	72,00

Koleno 45°	Kód	DN	€
	11060	60	5,00
	11080	80	3,70
	11100	100	9,90
	11110	110	6,00
	11125	125	11,80
	11160	160	16,10
	11200	200	55,00

Revízne koleno 87,5°	Kód	DN	€
	12060	60	15,40
	12080	80	14,60
	12100	100	13,40
	12110	110	12,40
	12125	125	17,40
	12160	160	20,70
	12200	200	88,00

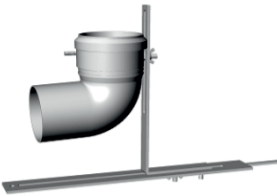
Koleno 87° s konzolou	Kód	DN	€
	47060	60	25,40
	47080	80	27,40
	47100	100	35,00
	47110	110	37,20
	47125	125	32,50
	47160	160	38,00
	47200	200	88,00

Spojka hrdlo - hrdlo	Kód	DN	€
	39060	60	10,40
	39080	80	12,80
	39100	100	18,00
	39110	110	13,60
	39125	125	15,20
	39160	160	17,60

Konzola pre koleno 87°	Kód	DN	€
	46060	60	14,60
	46080	80	14,90
	46100	100	17,90
	46110	110	18,90
	46125	125	19,90
	46160	160	22,50
	46200	200	24,50

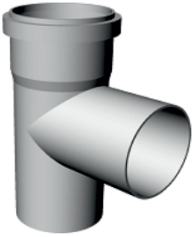
T - kus	Kód	DN	€
	25060	60	9,60
	25080	80	13,30
	25100	100	17,30
	25110	110	10,40
	25125	125	22,00
	25160	160	28,30
	25200	200	79,20

Revízny T - kus	Kód	DN	€
	16080	80	18,00
	16100	100	21,80
	16110	110	20,90
	16125	125	26,00
	16160	160	37,20
	16200	200	72,00

Revízny T - kus	Kód	DN	€
	16080X	80	14,60

Revízny T-kus vertikálny	Kód	DN	€
	17080	80	22,50
	17100	100	23,30
	17110	110	27,80
	17125	125	52,60
	17160	160	76,20
	17200	200	128,70

Zachytávač kondenzátu vertikálny	Kód	DN	€
	56080	80	15,60
	56100	100	22,00
	56110	110	17,32
	56125	125	18,40
	56160	160	20,20
	56200	200	59,00



Revízny uzáver s odvodom kondenzátu	Kód	DN	€
	28060	60	13,80
	28080	80	12,60
	28100	100	16,40
	28110	110	16,40
	28125	125	24,80
	28160	160	30,20
	28200	200	51,00

Revízny uzáver	Kód	DN	€
	29060	60	13,80
	29080	80	11,40
	29100	100	15,20
	29110	110	15,20
	29125	125	15,60
	29160	160	29,00

Revízny T-kus s odvodom kondenzátu	Kód	DN	€
	18080	80	18,50
	18100	100	31,30
	18110	110	22,90
	18125	125	52,60
	18160	160	59,90

Revízny T-kus s odvodom kondenzátu	Kód	DN	€
	16060OH	60	-
	16080OH	80	18,00
	16100OH	100	21,80
	16110OH	110	20,90
	16125OH	125	34,00
	16160OH	160	37,20

Zachytávač kondenzátu horizontálny	Kód	DN	€
	55080	80	7,50
	55110	110	8,30
	55125	125	9,00
	55160	160	10,70
	55200	200	59,00

Redukcia	Kód	dn/DN	€
 <p>smer spalín ↑</p>	366080	60/80	4,90
	3660100	60/100	14,20
	3660110	60/110	14,10
	3660125	60/125	19,20
	3660160	60/160	24,70
	3680100	80/100	12,40
	3680110	80/110	12,40
	3680125	80/125	16,90
	3680160	80/160	21,70
	36100110	100/110	11,00
	36100125	100/125	17,40
	36100160	100/160	21,20
	36110125	110/125	17,40
	36110160	110/160	22,70
	36125160	125/160	24,00
	36125160	125/200	Dopyt
36160200	160/200	Dopyt	
Redukcia	Kód	DN/dn	€
 <p>smer spalín ↑</p>	368060	80/60	18,30
	3610080	100/80	25,60
	3611080	110/80	34,10
	36110100	110/100	26,40
	3612580	125/80	17,30
	36125100	125/100	36,60
	36125110	125/110	39,00
	36160125	160/125	33,20
	36200160	200/160	Dopyt

ABGAS Mazadlo 250 g tuba	Kód	DN	€
	128943-003		2,46 €

Rozdeľovač	Kód	DN	€
	R601008080V	60/100 na 2x80	39,40
	R801258080V	80/125 na 2x80	39,40

Plochý rozdeľovač	Kód	DN	€
	PA425TBL	60/100 na 80/80	35,50
	7418011	60/100 na 60/60	35,50
	7418012	80/125 na 80/80	35,50

Komínová hlavica nerez	Kód	DN	€
	34060	60	15,60
	34075	75	17,90
	34080	80	17,90
	34100	100	20,70
	34110	110	29,10
	34125	125	29,50
	34160	160	42,80
	34200	200	46,20

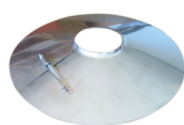

Nerezová hlavica výfuku	Kód	DN	€
	TERM06I	60	6,30
	TERM08I	80	8,80
	TERM10I	100	8,70
	890DH	125	18,00

Protidažďová manžeta	Kód	DN	€
	S0008	60	12,00
	S0009	80	13,00
	S0010	100	14,00
	S0014	110	17,00
	S0015	130	20,00
	S0016	150	24,00
	S0017	180	28,00
	S0018	200	30,00

Krycia manžeta lak. kov	Kód	DN	€
	M-930AG	60	2,90
	M-930BG	80	3,10
	M-930CG	100	3,90

Krycia manžeta gumená	Kód	DN	€
	830BG	80	2,70
	830CG	100	2,80
	830DG	125	4,54

Vystreďovacia objímka jednoduchá	Kód	DN	€
	37060	60	3,20
	37080	80	3,40
	37110	110	4,00
	37125	125	4,60
	37160	160	5,60
	37200	200	8,80

Redukcia	Kód	dn/DN	€
 <p>smer spalín ↑</p>	366080	60/80	4,90
	3660100	60/100	14,20
	3660110	60/110	14,10
	3660125	60/125	19,20
	3660160	60/160	24,70
	3680100	80/100	12,40
	3680110	80/110	12,40
	3680125	80/125	16,90
	3680160	80/160	21,70
	36100110	100/110	11,00
	36100125	100/125	17,40
	36100160	100/160	21,20
	36110125	110/125	17,40
	36110160	110/160	22,70
	36125160	125/160	24,00
	36125160	125/200	Dopyt
36160200	160/200	Dopyt	
Redukcia	Kód	DN/dn	€
 <p>smer spalín ↑</p>	368060	80/60	18,30
	3610080	100/80	25,60
	3611080	110/80	34,10
	36110100	110/100	26,40
	3612580	125/80	17,30
	36125100	125/100	36,60
	36125110	125/110	39,00
	36160125	160/125	33,20
	36200160	200/160	Dopyt

ABGAS Mazadlo 250 g tuba	Kód	DN	€
	128943-003		2,46 €

Rozdeľovač	Kód	DN	€
	R601008080V	60/100 na 2x80	39,40
	R801258080V	80/125 na 2x80	39,40

Plochý rozdeľovač	Kód	DN	€
	PA425TBL	60/100 na 80/80	35,50
	7418011	60/100 na 60/60	35,50
	7418012	80/125 na 80/80	35,50

Komínová hlavica nerez	Kód	DN	€
	34060	60	15,60
	34075	75	17,90
	34080	80	17,90
	34100	100	20,70
	34110	110	29,10
	34125	125	29,50
	34160	160	42,80
	34200	200	46,20

Nerezová hlavica výfuku	Kód	DN	€
	TERM06I	60	6,30
	TERM08I	80	8,80
	TERM10I	100	8,70
	890DH	125	18,00

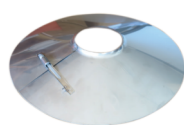
Protidažďová manžeta	Kód	DN	€
	S0008	60	12,00
	S0009	80	13,00
	S0010	100	14,00
	S0014	110	17,00
	S0015	130	20,00
	S0016	150	24,00
	S0017	180	28,00
	S0018	200	30,00

Krycia manžeta lak. kov	Kód	DN	€
	M-930AG	60	2,90
	M-930BG	80	3,10
	M-930CG	100	3,90

Krycia manžeta gumená	Kód	DN	€
	830BG	80	2,70
	830CG	100	2,80
	830DG	125	4,54

Vystreďovacia objímka jednoduchá	Kód	DN	€
	37060	60	3,20
	37080	80	3,40
	37110	110	4,00
	37125	125	4,60
	37160	160	5,60
	37200	200	8,80