

KOMÍNOVÉ SYSTEMY



**Nerezový izolovaný systém
DINAK DW**

DN: 80mm - 1200mm

EN 1856 AISI 316L



**Nerezový systém
DINAK SW**

DN: 80mm - 1200mm

EN 1856 AISI 316L



**Plastový koaxiálny systém
KOAX PP/AL a PP/PP**

DN: 60/100 a 80/125mm

EN14471



**Hliníkový koaxiálny systém
KOAX AL/AL**

DN: 60/100 a 80/125mm

EN14471 EN 1856-2



**Flexibilná plastová vložka
FLEX PP**

DN: 75mm - 140mm

EN14471 EN14472



**Flexibilná nerezová vložka
FLEX NOX**

DN: 80mm - 200mm

EN1856 AISI 316L



**Plastový systém
PLAST PP**

DN: 60mm - 315mm

EN14471



**Plastový UV odolný systém
PLAST PP UV**

DN: 60mm - 315mm

EN14471



**Oceľové dymovody
OCEĽ FE**

DN: 100mm - 250mm

EN 13063-1 ST 1303



**Hliníkový systém
Hliník AL**

DN: 60 - 100 mm

EN 1856-1 EN 1856-2

ABC PLYN

produktový katalóg - cenník 2016

www.abcplyn.sk/eshop/

ABC PLYN, spol. s r.o.

Československej armády 2, 036 01 Martin

IČO: 36 408 689 DIČ: 2020123380 IČ DPH: SK2020123380

Zapísaná v obchodnom registri okresného súdu Žilina, oddiel s.r.o, vložka číslo: 13913/L

Bankové spojenie: Tatra banka, účet: 2627371859/1100

tel: 043 - 42 24 809

fax: 043 - 43 01 888

e-mail: info@abcplyn.sk

www.abcplyn.sk**Cenové ponuky;****Montáž a doprava komínov;****Objednávky:****e-shop:** www.abcplyn.sk/eshop/**e-mail:** info@abcplyn.sk**fax:** 043/43 01 888**tel:** 043/42 24 809**Fakturácia:****Ivana Krupová**

- tel.: 043/42 24 809, e-mail: info@abcplyn.sk

- tel.: 0905 555 028

Obchodno - technický zástupcovia:**Richard Otčenáš**

- tel.: 0917 842 055, e-mail: otcenas@abcplyn.sk

Peter Turcer

- tel.: 0918 422 244, e-mail: turcer@abcplyn.sk

Odber tovaru:**1. Osobný odber** zo skladu ABC Plyn, s.r.o., Československej armády 2, Martin.**2. Doručenie kuriérom** Slovak Parcel Service (UPS) v nasledujúci pracovný deň v rámci celej SR.**Pri objednávke prijatej do 12:00****3. Paletová preprava** do 48 hodín v rámci celej SR.

Ceny sú platné pre sklad ABC PLYN, s.r.o. Martin.

Pri objednávke nad 100,- € bez DPH doprava zadarmo.

Pri objednávke do 100,- € bez DPH doprava 5,90 bez DPH

Vrátenie tovaru je akceptované po predchádzajúcom odsúhlasení firmou ABC Plyn. Tovar musí byť nepoškodený, nepoužitý a v originálnom balení. Po doručení materiálu bude zákazníkovi vrátené 85% z fakturovanej sumy tovaru.

OBSAH

➤ Kontaktné a fakturačné údaje	- 2 -
➤ Plastový systém / Kaskády / Koax / Flexi /	- 3 -
➤ FLEXI systém / Plast / Nerez	- 10 -
➤ Hliníkový systém / Koax /	- 12 -
➤ Komponenty	- 15 -
➤ Nerezový systém DINAK®/ DW / SW /	- 16 -
➤ Oceľové dymovody	- 32 -
➤ Čerpadlá	- 33 -
➤ Armatúry a filtračná technika	- 34 -
➤ Teplovzdušná a teplovodná technika	- 35 -
➤ DINAGAS systém	- 36 -
➤ DINAK®GE systém	- 38 -

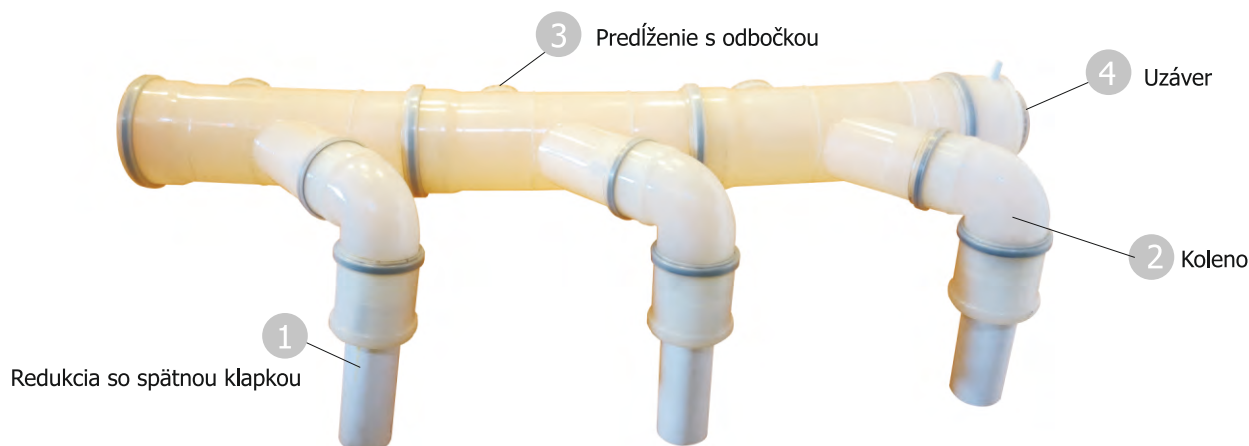

pre dva kotly	Ø zberača							
	Ø 110		Ø 125		Ø 160		Ø 200	
priemer výduchu kotla	cena bez klapiek	cena s klapkami	cena bez klapiek	cena s klapkami	cena bez klapiek	cena s klapkami	cena bez klapiek	cena s klapkami
Ø 80, Ø 100, Ø 110	154 €	276 €	169 €	291 €	181 €	341 €	229 €	389 €

pre tri kotly	Ø zberača							
	Ø 110		Ø 125		Ø 160		Ø 200	
priemer výduchu kotla	cena bez klapiek	cena s klapkami	cena bez klapiek	cena s klapkami	cena bez klapiek	cena s klapkami	cena bez klapiek	cena s klapkami
Ø 80, Ø 100, Ø 110	228 €	402 €	248 €	422 €	272 €	492 €	298 €	506 €

pre štyri kotly	Ø zberača							
	Ø 110		Ø 125		Ø 160		Ø 200	
priemer výduchu kotla	cena bez klapiek	cena s klapkami	cena bez klapiek	cena s klapkami	cena bez klapiek	cena s klapkami	cena bez klapiek	cena s klapkami
Ø 80, Ø 100, Ø 110	288 €	484 €	313 €	509 €	349 €	599 €	399 €	655 €

Kondenzačný uzáver



Kód	DN	€
P552GNb	110	22,90
P552DNb	125	26,90
P552HNb	160	35,00
P552NNb	200	51,00

Redukcia so spätnou klapkou



Kód	[dn / DN]	€
4211080	80 / 110	75,60
4212580	80 / 125	93,00
42110160	110 / 160	99,30

Výhodná cena rúr



Komínová rúra plastová biela - výhodná cena

Kód	DN	Dĺžka (mm)	Ks	Cena za ks €	Cena balíka €
19080	80	2000	1	12,80	-
19080	80	2000	8	11,90	95,20
19080	80	2000	16	10,90	174,40
22080	80	1000	1	7,50	-
22080	80	1000	8	6,30	50,40
19060	60	2000	1	10,20	-
19060	60	2000	10	9,90	99,00
19060	60	2000	20	9,60	192,00
22060	60	1000	1	7,10	-
22060	60	1000	10	6,70	67,00



Výhodná cena rúr

Komínová rúra plastová UV odolná čierna - výhodná cena

Kód	DN	Dĺžka (mm)	Ks	Cena za ks €	Cena balíka €
22080c	80	1000	1	9,70	-
22080c	80	1000	8	8,30	66,40

Vystreďovacia objímka UNI

Kód	ks	€	Balík
M3760200	1	2,90	—
M3760200	4	2,22	8,88



Vystreďovacia objímka jednoduchá

Kód	DN	ks	€	Balík
37060	60	1	3,20	—
37060	60	10	3,00	30,00
37080	80	1	3,40	—
37080	80	10	3,20	32,00



PLASTOVÝ SYSTÉM**ABC PLYN**

Rúra - predĺženie 2000 mm



Kód	DN	€
19060	60	10,20
19080	80	12,80
19100	100	15,90
19110	110	15,30
19125	125	23,20
19160	160	35,50
19200	200	dopyt

Koleno 87°



Kód	DN	€
10060	60	5,00
10080	80	3,70
10100	100	6,60
10110	110	6,60
10125	125	11,80
10160	160	16,10
10200	200	dopyt

Rúra - predĺženie 1000 mm



Kód	DN	€
22060	60	7,10
22080	80	7,50
22100	100	9,40
22110	110	9,70
22125	125	13,50
22160	160	21,00
22200	200	dopyt

Koleno 45°



Kód	DN	€
11060	60	5,00
11080	80	3,70
11100	100	9,90
11110	110	6,00
11125	125	11,80
11160	160	16,10
11200	200	dopyt

Rúra - predĺženie 1000 mm, UV odolná



Kód	DN	€
22080C	80	9,70
22100C	100	10,90
22110C	110	11,30
22125C	125	17,60
22160C	160	22,90

Revízne koleno 87,5°



Kód	DN	€
12060	60	-
12080	80	14,60
12100	100	13,40
12110	110	12,40
12125	125	17,40
12160	160	20,70
12200	200	dopyt

Rúra - predĺženie 500 mm



Kód	DN	€
21060	60	4,10
21080	80	5,50
21100	100	5,90
21110	110	6,10
21125	125	6,70
21160	160	12,60
21200	200	dopyt

Koleno 87°s konzolou

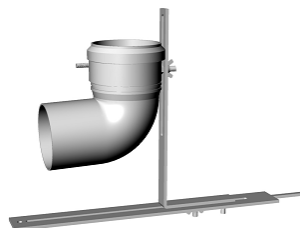

Kód	DN	€
47060	60	25,40
47080	80	27,40
47110	110	37,20
47125	125	32,50
47160	160	38,60
47200	200	dopyt

Rúra - predĺženie 250 mm



Kód	DN	€
20060	60	4,00
20080	80	3,50
20100	100	4,20
20110	110	4,40
20125	125	5,60
20160	160	11,80
20200	200	dopyt

Spojka hrdlo - hrdlo



Kód	DN	€
39060	60	10,40
39080	80	12,80
39100	100	18,00
39110	110	13,60
39125	125	15,20
39160	160	17,60

Ceny sú v € bez DPH a dopravy.

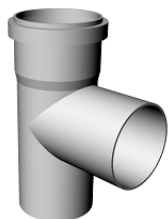
T-kus

Kód	DN	€
25060	60	9,60
25080	80	13,30
25100	100	17,30
25110	110	10,40
25125	125	22,00
25160	160	28,30
25200	200	dopyt

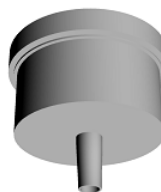
Revízny uzáver s odvodom kondenzátu

Kód	DN	€
28060	60	13,80
28080	80	12,60
28100	100	16,40
28110	110	16,40
28125	125	24,80
28160	160	30,20
28200	200	dopyt

Revízny T-kus

*univerzálny skrutkovací

Kód	DN	€
16080	80	18,00
*16080X	80	18,00
16100	100	21,80
16110	110	20,90
16125	125	26,00
16160	160	37,20
16200	200	dopyt

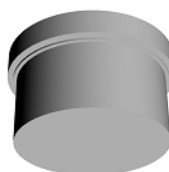
Revízny uzáver

Kód	DN	€
29060	60	13,80
29080	80	11,40
29100	100	15,20
29110	110	15,20
29125	125	15,60
29160	160	29,00
29200	200	dopyt

Revízny T-kus vertikál

Kód	DN	€
17080	80	22,50
17100	100	23,30
17110	110	27,80
17125	125	52,60
17160	160	76,20
17200	200	dopyt

T-kus revízny s odvodom kondenzátu

Kód	DN	€
18080	80	18,50
18100	100	31,30
18110	110	22,90
18125	125	52,60
18160	160	59,90
18200	200	dopyt

T-kus s konzolou

Kód	DN	€
49080	80	33,40
49110	110	38,80
49125	125	67,70
49160	160	94,10
49200	200	dopyt

Revízny T-kus s odvodom kondenzátu

Kód	DN	€
16080OH	80	18,00
16100OH	100	21,80
16110OH	110	20,90
16125OH	125	34,00
16160OH	160	37,20
16200OH	200	dopyt

Zachytávač kondenzátu horizontálny

Kód	DN	€
55080	80	7,50
55110	110	8,30
55125	125	9,00
55160	160	10,70

Zachytávač kondenzátu vertikálny

Kód	DN	€
56080	80	15,60
56110	110	17,20
56125	125	18,40
56160	160	20,20

PLASTOVÝ SYSTÉM**ABC PLYN**

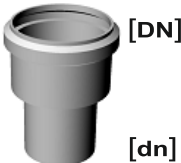
Redukcia [dn / DN]			
	Kód	[dn / DN]	€
	366080	60 / 80	7,40
	3660100	60 / 100	14,20
	3660110	60 / 110	14,10
	3660125	60 / 125	19,20
	3660160	60 / 160	24,70
	3680100	80 / 100	12,40

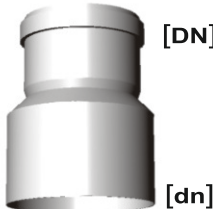
Redukcia [dn / DN]			
	Kód	[dn / DN]	€
	368060	80 / 60	18,30
	3610080	100 / 80	25,60
	3611080	110 / 80	34,10
	36110100	110 / 100	26,40
	3612580	125 / 80	17,30
	36125100	125 / 100	36,60
	36125110	125 / 110	39,00
	36140125	140 / 125	33,20
	36200160	200 / 160	dopyt

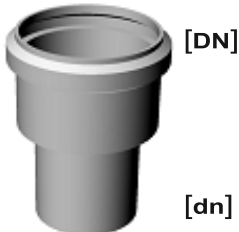
Redukcia [dn / DN]			
	Kód	[dn / DN]	€
	3680110	80 / 110	12,40
	3680125	80 / 125	16,90
	3680160	80 / 160	21,70
	36100110	100 / 110	11,00
	36100125	100 / 125	17,40
	36100160	100 / 160	21,20
	36110125	110 / 125	17,40
	36110160	110 / 160	22,70
	36125160	125 / 160	24,00
	36125200	125 / 200	dopyt
	36160200	160 / 200	dopyt

Rozdeľovač			
	Kód	[dn / DN na xdn]	€
	R601006060	60 / 100 na 2 x 60	56,30
	R601008080	60 / 100 na 2 x 80	39,40
	R801258080V	80 / 125 na 2 x 80	39,40

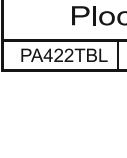
Zlučovač			
	Kód	€	
	S606060100	2 x 60 na 60 / 100	71,10
	S808080125	2 x 80 na 80 / 125	57,09

Plochý rozdeľovač			
	Kód	€	
	PA422TBL	DN 60/100 na DN 80/80	30,00

Protidažďová manžeta			
	Kód	DN	€
	S0008	60	12,00
	S0009	80	13,00
	S0010	100	14,00
	S0014	110	17,00
	S0015	130	20,00
	S0016	150	24,00
	S0017	180	28,00
	S0018	200	30,00

Krycia manžeta			
	Kód	DN	€
	830BG	80	2,70
	830CG	100	2,80
	830DG	125	3,20

Nerezová hlavica výfuku			
	Kód	DN	€
	TERM06I	60	6,30
	TERM08I	80	8,80
	TERM10I	100	8,70
	890 DH	125	21,30

Hlavica pre sanie vzduchu plast			
	Kód	DN	€
	TERM08P	80	1,90

Vystreďovacia objímka jednoduchá			
	Kód	DN	€
	37060	60	3,30
	37080	80	3,30
	37110	110	4,00
	37125	125	4,60
	37160	160	5,60
	37200	200	6,60

Vystreďovacia objímka zdvojená			
	Kód	DN	€
	37060/2	60	4,20
	37080/2	80	4,60
	37110/2	110	5,60
	37125/2	125	7,00
	37160/2	160	7,80
	37200/2	200	8,80

Ceny sú v € bez DPH a dopravy.

Koax. rúra - predĺženie 2000 mm Plast/Plast

Kód	dn/DN	€
M-PP60/100R2000V	60/100	24,90
PP80/125R2000V	80/125	37,00



Koax. koleno 90° Plast/Plast

Kód	dn/DN	€
M-PP60/100B90V	60/100	13,00



Koax. rúra - predĺženie 1000 mm Plast/Plast

Kód	dn/DN	€
M-PP60/100R1000V	60/100	14,90
PP80/125R1000V	80/125	23,50



Koax. koleno 45° Plast/Plast

Kód	dn/DN	€
M-PP60/100B45V	60/100	13,00



Koax. rúra - predĺženie 500 mm Plast/Plast

Kód	dn/DN	€
M-PP60/100R500V	60/100	11,00
PP80/125R500V	80/125	14,60



Koax. horizontálny komín Plast/Plast

Kód	dn/DN	€
M-PP60/100WD *	60/100	22,00

* Balenie obsahuje dva kusy a kryciu manžetu DN 100



Koax. rúra - predĺženie 250 mm Plast/Plast

Kód	dn/DN	€
M-PP60/100R250V	60/100	8,50
PP80/125R250V	80/125	11,50



Zachytávač kond. sanie/výfuk vertikál

Kód	dn/DN	€
PP60/100KA-2OV	60/100	32,80
PP80/125KA2OV	80/125	34,60



Rozdeľovač

Kód	[dn / DN na xdn]	€
R601008080V	60 / 100 na 2 x 80	39,40
R801258080V	80 / 125 na 2 x 80	39,40



PLASTOVÝ KOAXIÁLNY SYSTÉM**ABC PLYN**

Koax.rúra - predĺženie 2000 mm Plast / AL



Kód	dn/DN	€
PP60/100R2000	60/100	29,90
PP80/125R2000	80/125	45,00

Koax.koleno 90° Plast / AL



Kód	dn/DN	€
PP60/100B90	60/100	16,00
PP80/125B90	80/125	25,00

Koax.rúra - predĺženie 1000 mm Plast / AL



Kód	dn/DN	€
PP60/100R1000	60/100	16,90
PP80/125R1000	80/125	24,50

Koax.koleno 45° Plast / AL



Kód	dn/DN	€
PP60/100B45	60/100	16,00
PP80/125B45	80/125	24,30

Koax.rúra - predĺženie 500 mm Plast / AL



Kód	dn/DN	€
PP60/100R500	60/100	13,60
PP80/125R500	80/125	15,50

Koax.T-kus s revíznym otvorom Plast / AL



Kód	dn/DN	€
PA409TK	60/100	36,60
PA409EK	80/125	45,00

Koax.rúra - predĺženie 250 mm Plast / AL



Kód	dn/DN	€
PP60/100R250	60/100	10,90
PP80/125R250	80/125	13,90

Zachytávač kondenzátu



Kód	dn/DN	€
PP60/100KA200	60/100	17,10
PP80/125KA200	80/125	19,10

Koaxiálny komín - čierny



Kód	dn/DN	€
PP60/100DDBS	60/100	54,50
PP80/125DDBS	80/125	54,50

Koaxiálny komín - červený



Kód	dn/DN	€
PP60/100DDBR	60/100	54,50
PP80/125DDBR	80/125	54,50

Revízny kus



Kód	DN	€
PP60/100RS	60/100	30,00
PP80/125RS	80/125	39,00

Horizontálny komín



Kód	DN	€
PP60/100WD	60/100	21,00
PP80/125WD	80/125	28,00

Revízne koleno



Kód	dn/DN	€
PP60/100RB	60/100	34,00
PP80/125RB	80/125	44,00

Redukcia 3.012085



Kód	DN	€
PP60/100 - 80/125	---	18,50

Prechod strechou 25°- 50°

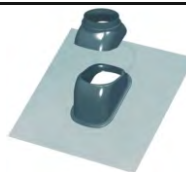

Kód	DN	€
ZB125UBPR červený	125	30,00
ZB125UBPS čierny	125	30,00

Ceny sú v € bez DPH a dopravy.

PLASTOVÝ FLEXI SYSTÉM**ABC PLYN**

Click and go system

Biela flexibilná rúra sa spája po presnom reze a po vložení tesnenia bez nutnosti použiť spojku.

Biela flexibilná plastová rúra

Obj. kód	DN	[bm] v kotúči	cena za [bm] v kotúči	cena kotúča
X0003	DN 60	1	8,90 €	-
X0003	DN 60	50	6,40 €	320,00 €
X0002	DN 80	1	9,90 €	-
X0001	DN 80	25	7,50 €	187,50 €
X0002	DN 80	50	6,50 €	325,00 €

Tesnenie

Kód	DN	€
31060	60	1,50
31080	80	1,60



F24075

Čierna flexibilná plastová rúra

Obj. kód	DN	[bm] v kotúči	cena za [bm] v kotúči	cena kotúča
24075	DN 75	1	10,40 €	-
F24075*	DN 80	30	7,50 €	225,00 €
24110	DN 110	25	11,60 €	290,00 €
24110	DN 110	1	14,52 €	-
24125	DN 125	25	13,10 €	327,50 €
24125	DN 125	1	17,16 €	-
24140	DN 140	25	16,00 €	400,00 €
24140	DN 140	1	19,36 €	-

*) Čierna flexibilná rúra DN80 má 2ks prizváraných prechodiek.

Spojka Flex/Flex

Kód	DN/DN	€
23075	80/80	26,60
23110	110/110	36,10
23125	125/125	39,80
23140	140/140	58,70

Prechod Flex/Predĺženie - vrchný

Kód	DN	€
277580	80	17,60
27110	110	20,60
27125	125	27,80
27140160	140	57,50

ABGAS Mazadlo 250g tuba

Kód	DN	€
128943-003		2,10

Prechod Predĺženie/Flex - spodný

Kód	DN	€
268075	80	14,30
26100110	100	25,70
26110	110	18,80
26125	125	25,00
26125140	125	26,00

NEREZOVÝ FLEXI SYSTÉM**ABC PLYN****MATERIÁL: AISI 316I / 1.4404 /**

Výhodná cena kotúča

Flexibilná nerezová vložka je certifikovaná pre pretlakovú a mokrú prevádzku.

Nerezová flexibilná univerzálna rúra

Obj. kód	DN	[bm] v kotúči	cena za [bm] v kotúči	cena kotúča
10.0110080	DN 80	1	10,99 €	-
10.0110080	DN 80	25	7,50 €	187,50 €
10.0110100	DN 100	1	13,63 €	-
10.0110100	DN 100	25	9,30 €	232,50 €
10.0110110	DN 110	1	15,29 €	-
10.0110110	DN 110	25	10,20 €	255,00 €
10.0110130	DN 130	1	17,77 €	-
10.0110130	DN 130	25	12,10 €	302,50 €
10.0110150	DN 150	1	20,55 €	-
10.0110150	DN 150	25	13,95 €	348,75 €
10.0110180	DN 180	1	24,66 €	-
10.0110180	DN 180	25	16,80 €	420,00 €
10.0110200	DN 200	1	28,53 €	-
10.0110200	DN 200	25	18,70 €	467,50 €

Spojka Flex/Flex

Kód	DN	€
FF80	80	13,90
FF80-KONDEN.	80	26,50
FF100	100	16,70
FF100-KONDEN.	100	28,50
FF110	110	18,00
FF130	130	21,20
FF150	150	27,20
FF180	180	32,20
FF200	200	47,30

Prechod Flex/Predženie - vrchný

Kód	DN	€
HF80	80	11,70
HF80 - konden.	80	28,42
HF100	100	14,70
HF100 - konden.	100	30,20
HF110	110	16,00
HF130	130	18,90
HF150	150	25,30
HF180	180	29,90
HF200	200	45,10

Prechod Predženie/Flex - spodný

Kód	DN	€
PF80	80	11,70
PF100	100	14,70
PF110	110	16,00
PF130	130	18,90
PF150	150	25,30
PF180	180	29,90
PF200	200	45,10

Protidažďová manžeta

Kód	DN	€
S0008	60	12,00
S0009	80	13,00
S0010	100	14,00
S0014	110	17,00
S0015	130	20,00
S0016	150	24,00
S0017	180	28,00
S0018	200	30,00

Komínová hlavica nerez

Kód	DN	€
34060	60	15,60
34075	75	17,90
34080	80	17,90
34100	100	20,70
34110	110	29,10
34125	125	29,50
34160	160	42,80
34200	200	46,20

Komínová hlavica - otočná

Kód	DN	€
OH150	150	49,92
OH160	160	49,92
OH180	180	49,92
OH200	200	49,92
OH250	250	58,25

Vystred'ovacia objímka jednoduchá

Kód	DN	€
37060	60	3,20
37080	80	3,40
37110	110	4,00
37125	125	4,60
37160	160	5,60
37200	200	6,60

Vystred'ovacia objímka zdvojená

Kód	DN	€
37060/2	60	4,20
37080/2	80	4,60
37110/2	110	5,60
37125/2	125	7,00
37160/2	160	7,80
37200/2	200	8,80

Ceny sú v € bez DPH a dopravy.

Pri objednávke nad 100 € bez DPH doprava zdarma do 24 hod! * Doručenie kuriérom Slovak Parcel Service (UPS) v nasledujúci pracovný deň v rámci celej SR.
 ABC PLYN, spol. s r.o., Československej armády 2, 036 01 Martin, tel.: 043/4224 809; fax: 043/4301 888, e-mail: info@abcplyn.sk, web: www.abcplyn.sk

Rúra - predĺženie 2000 mm AL - nelak.

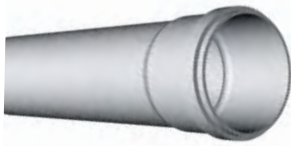

Kód	DN	€
120A	60	16,00
120B	80	18,70
120C	100	27,00

Koleno 90° AL - nelak.



Kód	DN	€
193AO	60	7,20
190BO	80	6,70
193CO	100	9,40

Rúra - predĺženie 2000 mm AL - lakovaná



Kód	DN	€
020A	60	17,50
020B	80	20,00
020C	100	30,00

Koleno 90° AL - lakované



Kód	dn/DN	€
093AO	60	7,80
090BO	80	7,00
093CO	100	11,00

Rúra - predĺženie 1000 mm AL - nelak.



Kód	DN	€
110A	60	8,40
110B	80	9,60
110C	100	13,90

Koleno 93° AL - lakovaný MM



Kód	DN	€
090BM	80	8,20

Rúra - predĺženie 1000 mm AL - lakovaná



Kód	DN	€
010A	60	9,30
010B	80	10,50
010C	100	17,00

Koleno 90° AL s meracím otvorom - lakované



Kód	DN	€
090BN	80	11,00

Rúra - predĺženie 500 mm AL - nelak.



Kód	DN	€
105A	60	5,50
105B	80	5,70
105C	100	9,00

Koleno 45° AL - nelak.



Kód	DN	€
145AO	60	7,80
145BO	80	6,70
145CO	100	9,40

Rúra - predĺženie 500 mm AL - lakovaná



Kód	DN	€
005A	60	5,80
005B	80	6,20
005C	100	10,50

Koleno 45° AL - lakované



Kód	DN	€
045AO	60	7,80
045BO	80	7,00
045CO	100	11,00

Rúra - predĺženie 250 mm AL - lakovaná



Kód	DN	€
002A	60	4,50
002B	80	5,00
002C	100	7,00

T-kus AL s uzáverom - nelak.



Kód	DN	€
509AK	60	21,00
509BK	80	19,00
509CK	100	22,50

T-kus AL s uzáverom - lakovaný



Kód	DN	€
409AK	60	20,20
409BK	80	20,20
409CK	100	25,00

Zachytávač kondenzu vertikálny AL - lakovaný



Kód	DN	€
417AN	60	18,10
417BN	80	16,00
417CN	100	20,00

Redukcia AL [dn / DN] - nelak.



Kód	dn/DN	€
580AR	60/80	7,00
519BR	80/100	9,20

Tesnenie



Kód	DN	€
810AG	60	1,60
810BG	80	1,90
810CG	100	2,50

Redukcia AL [dn / DN] - lakovaná



Kód	dn/DN	€
480AR	60/80	7,50
419BR	80/100	9,50
426CR	100/125	11,00

Spojka AL - lakovaná



Kód	DN	€
478AM	60	7,50
413BM	80	7,50
415CM	100	11,30

Spojka AL - nelakovaná



Kód	DN	€
578AM	60	5,60
513BM	80	6,90
515CM	100	10,00

Spojovacia objímka



Kód	DN	€
425AO	60	5,60
425BO	80	4,00
425CO	100	4,00
425DO	125	4,00

Upevňovací strmeň biely



Kód	DN	€
7176762	100	5,50
7176664	125	7,90
M-902 A	60	2,90
M-902 B	80	3,90
M-902 C	100	5,50

Nerezová hlavica výfuku - horizontálna



Kód	DN	€
TERM06I	60	6,30
TERM08I	80	8,80
TERM10I	100	8,70
890DH	125	21,30

Protidažďová manžeta



Kód	DN	€
S0008	60	12,00
S0009	80	13,00
S0010	100	14,00
S0014	110	17,00
S0015	130	20,00
S0016	150	24,00
S0017	180	28,00
S0018	200	30,00

Komínová hlavica nerez



Kód	DN	€
34060	60	15,60
34075	75	17,90
34080	80	17,90
34100	100	20,70
34110	110	29,10
34125	125	29,50
34160	160	42,80
34200	200	46,20

Komínová hlavica - otočná



Kód	DN	€
OH150	150	49,92
OH160	160	49,92
OH180	180	49,92
OH200	200	49,92
OH250	250	58,25

Príruba okrúhla/hranatá - Immergas



Kód	DN	€
460BP hranatá	80	14,62
461BP okrúhla	80	13,08

Hlavica pre sanie vzduchu - plast



Kód	DN	€
TERM08P	80	1,90

Koax. rúra - predĺženie 2000 mm AL / AL



Kód	dn/DN	€
AL60/100R2000	60/100	40,00
AL80/125R2000	80/125	55,00

Koax. koleno 87° AL / AL



Kód	dn/DN	€
AL60/100B90	60/100	16,00
AL80/125B90	80/125	22,00

Koax. rúra - predĺženie 1000 mm AL / AL



Kód	dn/DN	€
AL60/100R1000	60/100	20,00
AL80/125R1000	80/125	24,50

Koax. koleno 45° AL / AL



Kód	dn/DN	€
AL60/100B45	60/100	16,00
AL80/125B45	80/125	22,00

Koax. rúra - predĺženie 500 mm AL / AL



Kód	dn/DN	€
AL60/100R500	60/100	13,60
AL80/125R500	80/125	15,50

Revízné koleno s otvorom



Kód	DN	€
AL60/100RB	60/100	48,00
AL80/125RB	80/125	59,00

Koax. rúra - predĺženie 250 mm AL / AL



Kód	dn/DN	€
AL60/100R250	60/100	14,00
AL80/125R250	80/125	18,00

Koax. T-kus s revíznym otvorom AL / AL



Kód	dn/DN	€
409TK	60/100	29,00
409EK	80/125	42,30

Redukcia AL / AL



Kód	[dn/DN-dn/DN]	€
426TR	60/100-80/125	18,50

Revízny kus s dvierkami



Kód	dn/DN	€
AL60/100RS	60/100	30,00
AL80/125RS	80/125	33,00

Rozdeľovač AL / AL



Kód	[dn/DN na xdn]	€
422TT	60/100 na 2 x 80	17,50
422ET	80/125 na 2 x 80	24,00
422TBL*	60/100 na 2 x 80	24,00

* rozdeľovač plochý

Zachytávač kondenzátu



Kód	dn/DN	€
AL60/100KA200	60/100	25,00
AL80/125KA200	80/125	32,00

Príruba koax. AL / AL - Immergas



Kód	dn/DN	€
RTVI610B	60/100	20,00

Horizontálny komín



Kód	DN	€
AL60/100WD	60/100	21,00
AL80/125WD	80/125	26,30

Koaxiálny komín - čierny



Kód	dn/DN	€
AL60/100DDHS	60/100	54,50
AL80/125DDHS	80/125	54,50

Koaxiálny komín - červený



Kód	dn/DN	€
AL60/100DDHR	60/100	54,50
AL80/125DDHR	80/125	54,50

Komínová hlavica nerez



Kód	DN	€
34060	60	15,60
34075	75	17,90
34080	80	17,90
34100	100	20,70
34110	110	29,10
34125	125	29,50
34160	160	42,80
34200	200	46,20

Komínová hlavica čierna AL



Kód	DN	€
416AS	60	23,70
417BS	80	18,50
418CS	100	20,80
419DS	110	45,00
420ES	125	36,00
428HS	160	40,00

Horizontálna hlavica výfuku nerez



Kód	DN	€
TERM06I	60	6,30
TERM08I	80	8,80
TERM10I	100	8,70
890DH	125	21,30

Ukončovací kryt komína - plast

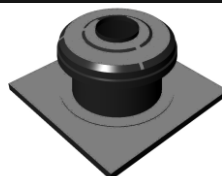

Kód	DN	Platňa	€
ZB80SCHA	80	40x40 cm	59,20
ZB100SCHA	100	30x30 cm	73,20

Horizontálna hlavica výfuku nerez - koax.



Kód	dn/DN	€
890TH	60/100	16,70
890EH	80/125	21,50

Hlavica pre sanie vzduchu - plast



Kód	DN	€
TERM08P	80	1,90

Krycia manžeta lak. kov



Kód	DN	€
M-930AG	60	2,90
M-930BG	80	3,10
M-930DG	100	3,90

Tesnenie



Kód	DN	€
31060	60	1,50
31080	80	1,60
31100	100	1,60
31110	110	1,60
31125	125	4,00
31160	160	4,00

Prechod strechou rovný

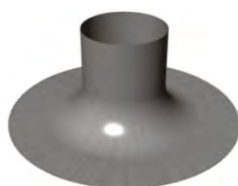

Kód	DN	€
ZB125FDK	125	20,00

Prechod strechou 25° - 50°

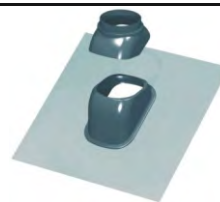

Kód	DN	€
ZB125UBPR červený	125	30,00
ZB125UBPS čierny	125	30,00

Vystreďovacia objímka jednoduchá



Kód	DN	€
37060	60	3,30
37080	80	3,30
37110	110	4,00
37125	125	4,60
37160	160	5,60

Vystreďovacia objímka zdvojená



Kód	DN	€
37060/2	60	4,20
37080/2	80	4,60
37110/2	110	5,60
37125/2	125	7,00
37160/2	160	7,80
37200/2	200	8,80

Komínová hlavica nerez + UV plast



Kód	DN	€
34080V	80	26,00
34100V	100	28,00
34110V	110	29,00
34125V	125	46,00
34160V	160	57,00

Kotviaci prvok



Kód	DN	€
32060	60	0,75
32080	80	1,25
32110	110	2,10
32125	125	2,60
32160	160	3,30
32200	200	4,17

EN 1856-1 T160 P1 W V2 L50040 O(50)

EN 1856-1 T160 P1 W V2 L50040 O(50) // EN 1856-2 T600 N1 W V2 L50040 G



JEDNOPLÁŠŤOVÝ KOMÍNOVÝ SYSTÉM Z NEREZOVEJ OCELE

DINAK

Priemer komína v mm

Dĺžka komína	Ø130	Ø150	Ø160	Ø180	Ø200
4m	157,60 €	176,76 €	192,30 €	207,45 €	232,55 €
5m	179,25 €	201,28 €	219,20 €	236,55 €	264,50 €
6m	200,92 €	225,80 €	245,98 €	265,64 €	296,41 €
7m	222,60 €	250,32 €	272,81 €	294,75 €	328,40 €
8m	244,27 €	274,86 €	299,70 €	323,85 €	360,30 €

EN 1856-1 T450 N1 W V2 L50040 O40 // EN 1856-1 T600 N1 W V2 L50040 G60

EN 1856-1 T160 P1 W V2 L50040 O00

DVOJPLÁŠŤOVÝ IZOLOVANÝ KOMÍNOVÝ SYSTÉM Z NEREZ. OCELE

DINAK

Priemer komína v mm

Dĺžka komína	Ø130	Ø150	Ø180	Ø200	Ø250
4m	348,42 €	387,60 €	449,68 €	534,40 €	672,80 €
5m	403,41 €	448,76 €	517,77 €	617,42 €	778,55 €
6m	458,40 €	509,98 €	585,88 €	700,50 €	884,30 €
7m	513,35 €	571,15 €	653,98 €	783,47 €	990,10 €
8m	568,35 €	632,34 €	722,10 €	866,49 €	1 095,81 €



*Komínová sada obsahuje: protidažďovú hlavicu; rovné predĺženie v počte podľa výšky komína;

T- kus; zátku s odvodom kondenzátu; spojovacie objímky;

*Ostatný sortiment je voliteľný podľa potreby z nášho katalógu.

*Možnosť vyskladať kaskády ku kondenzačným kotlom.

*Na uvedené ceny nie je možné uplatňovať ďalšiu zľavu.

NEREZOVÝ KOAXIÁLNY SYSTÉM

EN 1856-1 T200 P1 W V2 L50040 O50

Materiál: Nerezová oceľ AISI 316L (Trieda 1.4404)

Obsahuje: dve tesnenia príslušného priemeru

Odolnosť voči kondenzátu: Áno

Tepelná odolnosť: 200°C

Palivo: plyn, olej

Spotrebič: kondenzačný kotol, turbo kotol



Koax. vertikálny komín
Inox/Inox 650 mm

Kód	dn/DN	€
120K60/100	60/100	62,10
120K80/125	80/125	74,80

Koax. koleno 90° Inox/Inox

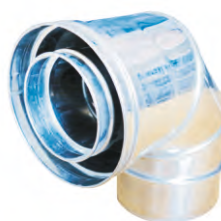

Kód	dn/DN	€
043K60/100	60/100	38,80
043K80/125	80/125	40,70

Koax. rúra - predĺženie 940 mm Inox/Inox

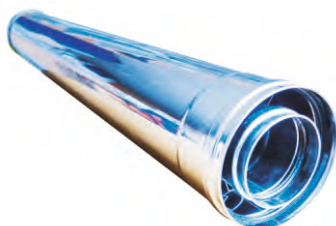

Kód	dn/DN	€
020K60/100	60/100	45,50
020K80/125	80/125	52,10

Koax. koleno 45° Inox/Inox



Kód	dn/DN	€
040K60/100	60/100	32,90
040K80/125	80/125	34,30

Koax. rúra - predĺženie 440 mm Inox/Inox

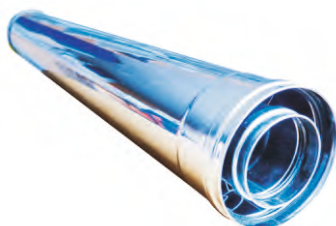

Kód	dn/DN	€
024K60/100	60/100	31,90
024K80/125	80/125	34,50

Koax. horizontálny komín Inox/Inox 700mm



Kód	dn/DN	€
M-PP60/100WD	60/100	52,60
M-PP80/125WD	80/125	60,00

Koax. rúra - predĺženie 270 mm Inox/Inox

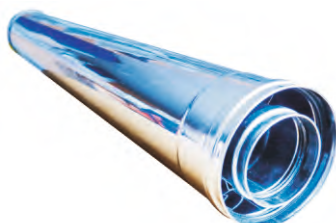

Kód	dn/DN	€
025K60/100	60/100	25,20
025K80/125	80/125	26,20

T - kus 93° Inox/Inox

Kód	dn/DN	€
031K60/100	60/100	38,60
031K80/125	80/125	40,20

*Kompletný sortiment nájdete na stránke www.abcplyn.sk

*Tovar nie je skladosm, dodacie doby na vyžiadanie

DVOJPLÁŠŤOVÝ IZOLOVANÝ KOMÍNOVÝ SYSTÉM Z NEREZOVEJ OCELE



Materialy EN 1856-1 T600 N1 W V2 L50040 G60
AISI 316L (1.4404) EN 1856-1 T450 N1 W V2 L50040 O40
 EN 1856-1 T160 P1 W V2 L50040 O00

Materialy EN 1856-1 T600 N1 W Vm L20040 G60
AISI 304 (1.4301) EN 1856-1 T450 N1 W Vm L20040 O40
 EN 1856-1 T160 P1 W Vm L20040 O00



0036

DW

0036 CPD 90220 001

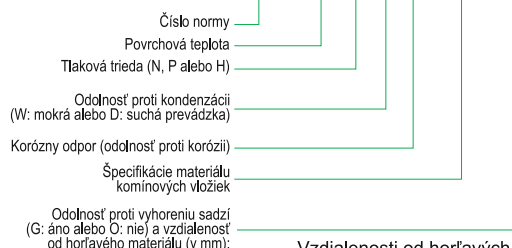

Vzdialenosti od horľavých materiálov
 týkajúce sa montáže kominov s ventiláciou

POUŽITIE

- ☑ SYSTÉMY VYKUROVANIA DOMÁCNOSTÍ A TEPLOVODNÉ SYSTÉMY
- ☑ VYKUROVANIE PRIEMYSELNÝCH A HOSPODÁRSKÝCH BUDOV
- ☑ PEKÁRENSKÉ PECE
- ☑ OTVORENÉ KRBY
- ☑ GENERÁTORY HORÚCEHO VZDUCHU
- ☑ VENTILÁCIA A ODVOD SPALÍN

ZÁKLADNÉ VLASTNOSTI

- ☑ NAVRHNUTÉ PRE MOKRÚ PREVÁDZKU S TESNENÍM A SUCHÚ PREVÁDZKU BEZ TESNENIA
- ☑ TEPELNÉ ROZPÍNANIE JE ABSORBOVANÉ JEDNOTLIVÝMI ČLÁNKAMI. NIE SÚ POTREBNÉ „KOMPENZAČNÉ VLNOVCE“
- ☑ NEMAJÚ TEPELNÝ MOST, SÚVISLÁ IZOLÁCIA PO CELOM SYSTÉME
- ☑ VYSOKÝ MECHANICKÝ ODPOR PROTI VERTIKÁLNYM A HORIZONTÁLNYM SILÁM
- ☑ PREKRYTIE SPOJOV: 40 mm
- ☑ K DISPOZÍCII SÚ PRIEMERY OD 80-1000 mm

☑ **MATERIÁLY**

- **Vnútorná stena:**
 - AISI 316L (Trieda 1.4404) alebo AISI 304 (Trieda 1.4301)
- **Vonkajšia stena:**
 - AISI 304 (Trieda 1.4301) alebo AISI 316L (Trieda 1.4404)
 - hliník
 - meď
 - farbená (rozsah vzorkovnice RAL)
- **Izolácia:**
 - minerálna vlna, 30-50 mm v závislosti od priemeru
- **Palivo:**
 - plyn, olej, drevo, biomasa

☑ **PRACOVNÁ TEPLOTA**

600°C pri nepretržitom ohni.
 Pre vyššie teploty kontaktujte dodávateľa

☑ **PRETLAK**

200 Pa s tesnením

☑ **VNÚTORNÉ/VONKAJŠIE PRIEMERY, HRÚBK A HMOTNOSŤ**

Vnútorný priemer (v mm)	80	100	130	150	180	200	250	300	350	400	450	500	550	600
Vonkajší priemer (v mm)	140	160	190	210	240	260	310	360	425	475	525	575	625	675
Hmotnosť (v kg) na rúru 940 mm	3.6	4.3	5.2	5.8	6.7	7.3	8.8	10.4	15.2	17.1	19.0	20.9	22.9	24.8
Izolácia (v mm)	30	30	30	30	30	30	30	30	37,5	37,5	37,5	37,5	37,5	37,5
Hrúbka nerezovej vrstvy (v mm)	0,4	0,4	0,4	0,4	0,4	0,4	0,4	0,4	0,5	0,5	0,5	0,5	0,5	0,5

RÚRY

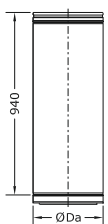

020

Dĺžka rúry
940 mm



070

Spojovacia
objímka

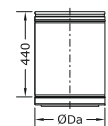
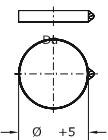

024

Dĺžka rúry
440 mm

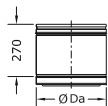

025

Dĺžka rúry
270 mm



001

Tesnenie

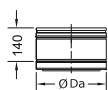

255

Dĺžka rúry 140 mm



NASTAVITEĽNÉ RÚRY

022

Nastaviteľná rúra
530-880 mm

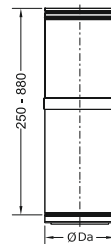

023

Nastaviteľná rúra
350-530 mm

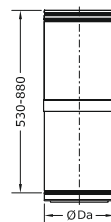

235

Nastaviteľná rúra
250-880 mm

TLMIČ

021

Tlmič 940 mm



KOLENÁ

044 Koleno 15°

Ø mm	80	100	130	150	180	200	250	300	350	400	450	500	550	600
ØDa mm	140	160	190	210	240	260	310	360	425	475	525	575	625	675
A mm	70	70	75	75	80	80	80	85	90	90	100	100	100	105
A1 mm	110	110	115	115	120	120	120	125	130	130	140	140	140	145

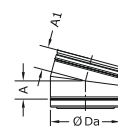

042 Koleno 30°

Ø mm	80	100	130	150	180	200	250	300	350	400	450	500	550	600
ØDa mm	140	160	190	210	240	260	310	360	425	475	525	575	625	675
A mm	75	80	80	85	90	90	100	105	110	120	130	130	140	145
A1 mm	115	120	120	125	130	130	140	145	150	160	170	170	180	185

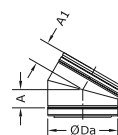

040 Koleno 45°

Ø mm	80	100	130	150	180	200	250	300	350	400	450	500	550	600
ØDa mm	140	160	190	210	240	260	310	360	425	475	525	575	625	675
A mm	80	85	90	95	100	105	115	125	135	145	165	170	180	190
A1 mm	120	125	130	135	140	145	155	165	180	190	205	210	220	230

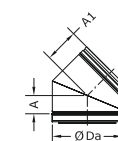

043 Koleno 87°

Ø mm	80	100	130	150	180	200	250	300	350	400	450	500	550	600
ØDa mm	140	160	190	210	240	260	310	360	425	475	525	575	625	675
043 A mm	160	170	190	200	210	220	250	270	305	350	355	380	405	430
043 A1 mm	190	200	215	225	240	250	270	295	325	370	375	400	420	445
433 A mm	165	165	180	190	205	215	240	265	300	325	350	375	400	425
433 A1 mm	205	205	220	230	245	255	280	305	340	365	390	415	440	465

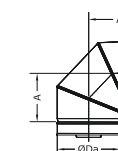

433 Koleno 90°

431 Revízne koleno 87°

Ø mm	80	100	130	150	180	200	250	300	350	400	450	500	550	600
ØDa mm	140	160	190	210	240	260	310	360	425	475	525	575	625	675
431 A mm	190	210	225	230	265	270	300	275	310	325	330	355	380	405
431 A1 mm	220	240	255	260	295	300	330	305	335	350	375	400	425	450
432 A mm	170	180	215	225	250	255	290	275	300	315	330	355	375	405
432 A1 mm	215	225	260	270	275	300	335	320	345	360	355	380	405	430
Øl mm	80	100	130	150	150	150	150	150	150	150	150	150	150	150

432 Revízne koleno 90°

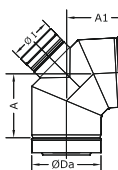

T-KUSY

030 T-kus 135° – vhodný iba pre suchú a podtlakovú prevádzku

Ø mm	130	150	180	200	250	300	350	400	450	500	550	600
E mm	440	440	440	610	610	690	940	940	940	940	1030	1100
F mm	115	110	110	195	145	185	265	205	185	200	210	220
G mm	215	235	255	300	320	365	420	460	505	550	575	625
ØDa mm	190	210	240	260	310	360	425	475	525	575	625	675

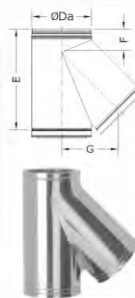

312
Redukovaný T - kus 90°

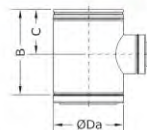

31B
Redukovaný T - kus 93°



031 T - kus 90°

31A T - kus 93°

Ø mm	80	100	130	150	180	200	250	300	350	400	450	500	550	600
B mm	270	270	270	440	440	440	440	610	610	610	940	940	940	904
C mm	150	150	150	230	230	230	230	315	315	315	485	485	485	485
D mm	100	110	125	135	150	160	185	210	245	270	320	350	370	400

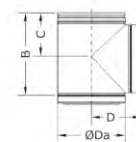

HLAVICE

011 Izolované otvorené ukončenie

Ø mm	80	100	130	150	180	200	250	300	350	400	450	500	550	600
N mm	115	115	115	115	115	115	115	115	280	280	280	280	280	280



010 Hlavica proti dažďu

012 Hlavica proti vetru

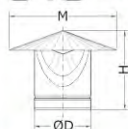

Ø mm	80	100	130	150	180	200	250	300	350	400
M mm	230	270	330	370	420	470	570	670	780	880
H mm	220	245	280	315	330	345	405	430	540	595

12G Ukončovaci diel proti vetru



015 Horizontálne ukončenie komína

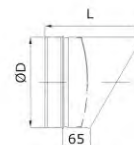

REVÍZNE KUSY

052

Revízny kus s dvierkami 440 mm

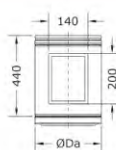

050

Rúra s meracím otvorom

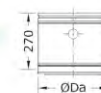

523 Revízny T - kus (pre mokrú prevádzku)

Ø mm	80	100	130	150	180	200	250	300	350	400	450	500	550	600
B mm	270	270	270	440	440	440	440	610	610	610	940	940	940	940
C mm	150	150	150	230	230	230	230	315	315	315	485	485	485	485
D mm	100	110	125	135	150	160	185	210	245	270	295	325	345	395

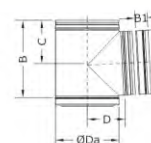

056 Rúra s teplomerom 440 mm

Ø mm	80	100	130	150	180	200	250	300	350	400	450	500	550	600
K1 mm	440	440	440	440	440	440	440	440	440	440	440	440	440	440

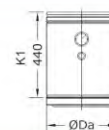

060 Uzáver revízny

061 Uzáver revízny s odvodom kondenzátu



NEREZOVÝ KOMÍNOVÝ SYSTÉM DW

ABC PLYN

100 Adaptér kotla

Ø mm	80	100	130	150	180	200	250	300	350	400
Da mm	140	160	190	210	240	260	310	360	425	457
ØA mm	82	102	132	152	182	202	252	302	352	402

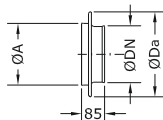

122 Stabilizátor ťahu

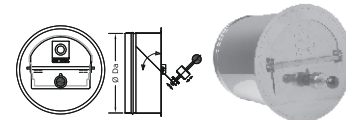

1C0 Adaptér kondenzačného kotla

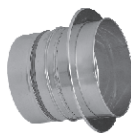
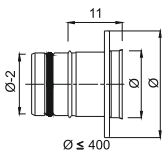

026 Redukcia

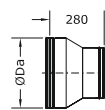

105 FK/DW prechod

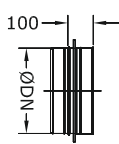

106 DW/FK prechod

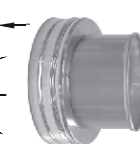
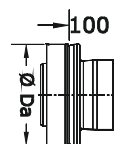

120 Regulátor ťahu

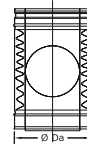

017 Prechod strechou - nastaviteľné lemovanie 30 - 45° s protidažďovou manžetou

Ø mm	80	100	130	150	180	200	250	300	350	400	450	500	550	600
W1 mm	170	195	220	240	270	285	345	405	475	495	545	595	645	700
Y mm	300	345	400	430	480	520	600	660	760	840	910	990	1.070	1.150

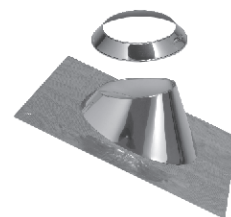
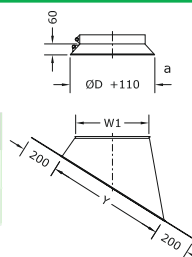

018 Prechod strechou - nastaviteľné lemovanie 5 - 30° s protidažďovou manžetou

Ø mm	80	100	130	150	180	200	250	300	350	400	450	500	550	600
W mm	150	175	200	230	275	295	350	390	460	495	545	595	645	700
X mm	225	260	295	320	360	380	450	500	590	640	700	760	820	880

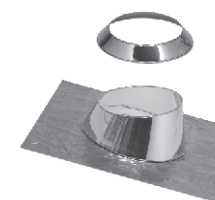
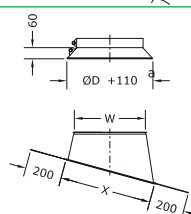

013 Protidažďová manžeta

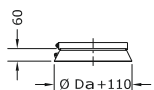

014 Stenové komínové predĺženie

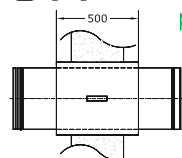

019 Prechod strechou - lemovanie 0° s protidažďovou manžetou

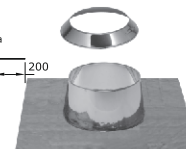
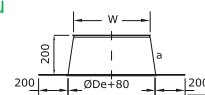

132 Krycia doska 30 - 45°

Ø mm	80	100	130	150	180	200	250	300	350	400	450	500	550	600
A mm	215	230	250	265	285	300	335	370	415	450	485	525	560	595
B mm	380	400	430	450	480	500	550	600	665	715	765	815	865	915

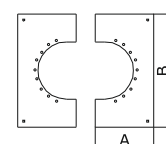

064 Protipožiarna doska

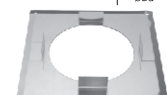
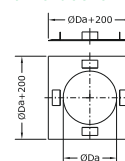

133 Krycia doska 0 - 30°

Ø mm	80	100	130	150	180	200	250	300	350	400	450	500	550	600
A mm	205	205	220	235	250	260	290	315	355	385	415	445	470	500
B mm	380	400	430	450	480	500	550	600	665	715	765	815	865	915

854 Rúra s konzolovou doskou

Ø mm	80	100	130	150	180	200	250	300	350	400	450	500	550	600
A mm	170	170	175	270	310	340	350	410	485	545	570	630	685	745
B mm	270	270	270	320	350	370	420	670	535	585	635	685	735	785

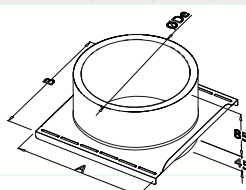
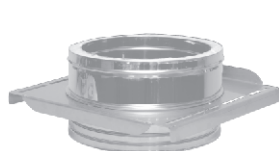

856

Nastaviteľný podlahový držiak

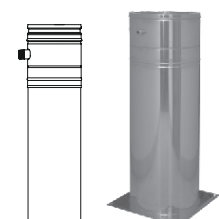

065

Základová doska s odvodom kondenzátu

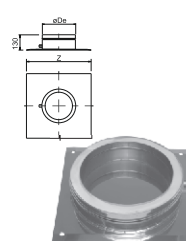

NEREZOVÝ KOMÍNOVÝ SYSTÉM DW

ABC PLYN

857 Konzola

Ø mm	80	100	130	150	180	200	250	300	350	400	450	500	550	600
L mm	155	180	190	225	260	295	310	365	440	500	525	575	635	685
H mm	170	205	215	250	285	320	335	390	465	525	550	600	660	710

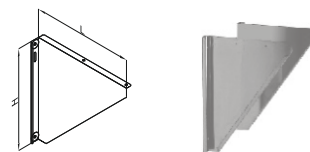

858 Konzolová doska s odvodom kondenzátu

Ø mm	80	100	130	150	180	200	250	300	350	400	450	500	550	600
A mm	195	215	245	340	380	410	420	480	555	615	645	705	765	825
B mm	285	305	335	380	410	430	480	530	595	645	695	745	795	845

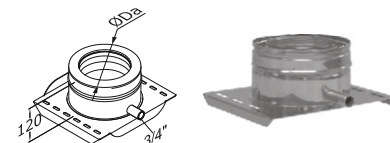

080 Stenový držiak

Ø mm	80	100	130	150	180	200	250	300	350	400	450	500	550	600
R mm	30	30	30	35	40	45	25	30	35	40	20	25	25	30
S mm	175	195	220	250	280	310	340	395	465	520	550	605	655	710
T mm	60	60	120	120	120	120	190	190	190	190	270	270	270	270

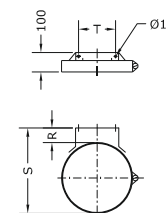

083 Nastaviteľný stenový držiak 70-120 mm (pre q od 80-300 mm)

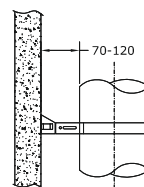

835

Nastaviteľný stenový držiak
100-250 mm

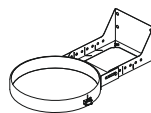

845

Nastaviteľný stenový držiak
250-430 mm

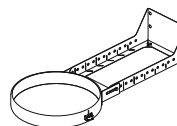

086

Plochý stenový držiak

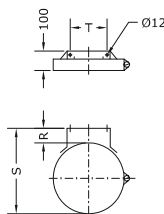

831

Plochý nastaviteľný stenový držiak 70-120 mm
(pre q od 80-300 mm)

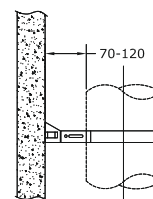

836

Plochý nastaviteľný
stenový držiak 100-250 mm

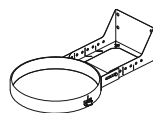

846

Plochý nastaviteľný stenový držiak
250-430 mm

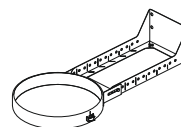

082

Strešný držiak

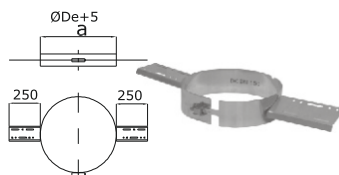

110

Uzemňovacia objímka

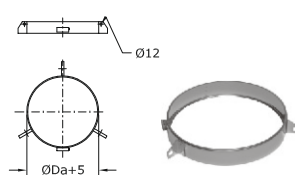

071

Dištančná objímka

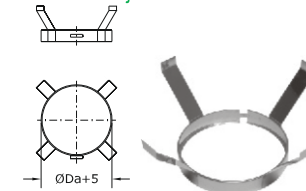

074

Závesná objímka

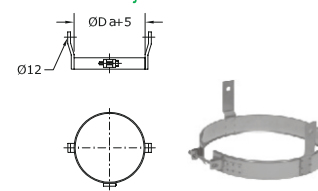

PRÍKLADY MONTÁŽE VRÁTANE NASTAVITEĽNÝCH RÚR

T – KUSY A KOLENÁ

E = Nastaviteľná rúra L = Celková požadovaná dĺžka komína

Ø mm	80	100	130	150	180	200	250	300	350	400	450	500	550	600
d mm	100	110	125	140	160	175	180	210	253	278	283	313	338	368
j mm	150	150	150	230	230	230	230	315	315	315	485	485	485	485
k mm	225	225	225	315	315	315	315	400	400	400	560	560	560	560
q mm	300	320	350	375	410	435	465	520	598	648	703	763	808	868

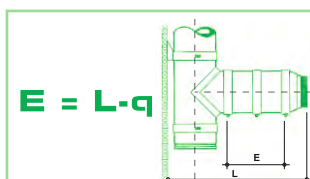
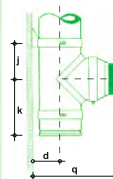

Ø mm	80	100	130	150	180	200	250	300	350	400	450	500	550	600
a mm	545	575	610	656	705	753	815	938	1058	1140	1219	1300	1377	1484
b mm	275	290	305	331	355	383	430	488	555	602	661	702	744	811
c mm	445	475	510	556	605	653	715	838	958	1040	1119	1200	1277	1384
d mm	100	110	125	140	160	175	180	210	253	278	283	313	338	368
f mm	115	115	115	110	110	195	145	185	265	205	185	200	210	220
g mm	405	405	430	435	435	520	570	610	780	840	860	845	925	985

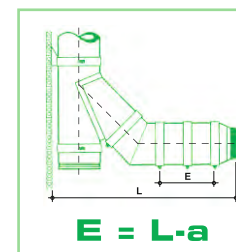
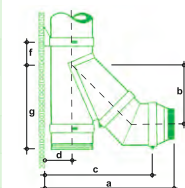

Ø mm	80	100	130	150	180	200	250	300	350	400	450	500	550	600
d mm	100	110	125	140	160	175	180	210	253	278	283	313	338	368
o mm	384	401	358	376	393	410	444	546	580	615	674	717	751	785
p mm	159	166	148	156	163	170	184	226	240	255	279	297	311	325

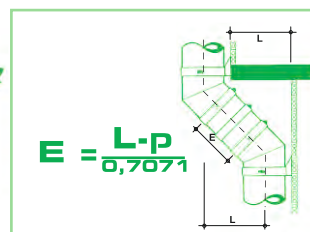
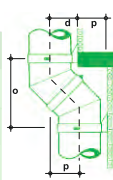

T - KUSY, KOLENÁ A NASTAVITEĽNÉ RÚRY

E = Nastaviteľná rúra L = Celková požadovaná dĺžka komína

Ø mm	80	100	130	150	180	200	250	300	350	400	450	500	550	600
d mm	100	110	125	140	160	175	180	210	253	278	283	313	338	368
j mm	150	150	150	230	230	230	230	315	315	315	485	485	485	485
k mm	225	225	225	315	315	315	315	400	400	400	560	560	560	560
l mm	494	526	528	566	613	650	704	826	928	1002	1102	1194	1264	1348
m mm	249	261	228	241	253	265	289	366	390	415	454	482	506	530
n mm	349	361	328	341	353	365	389	466	490	515	554	582	606	630

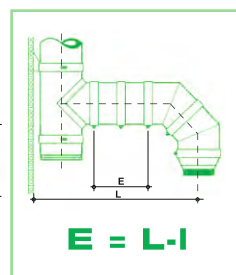
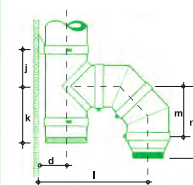

Ø mm	80	100	130	150	180	200	250	300	350	400	450	500	550	600
d mm	100	110	125	140	160	175	180	210	253	278	283	313	338	368
e mm	375	400	430	471	515	558	610	698	808	880	944	1015	1082	1179
f mm	115	115	115	110	110	195	145	185	265	205	185	200	210	220
g mm	405	405	430	435	435	520	570	610	780	840	860	845	925	985
h mm	345	365	385	416	445	478	535	628	705	762	836	887	939	1016
i mm	445	465	485	516	545	578	635	728	805	862	936	987	1039	1116

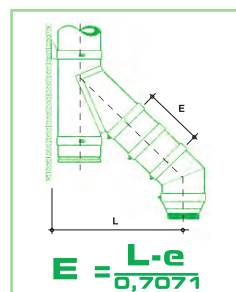
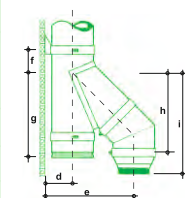

Ø mm	80	100	130	150	180	200	250	300	350	400	450	500	550	600
m mm	249	261	228	241	253	265	289	366	390	415	454	482	506	530
r mm	294	306	278	291	303	315	339	406	430	455	499	532	556	580

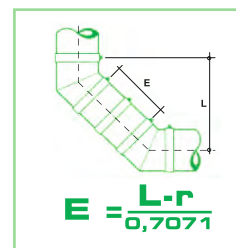

DVOJPLÁŠŤOVÝ IZOLOVANÝ SYSTÉM DINAK® DW 316L/304



SK	RÚRY						KOLENÁ				T-KUSY			
	020	024	025	022	023	021	040	042	043	432	031	030*	523	
DN	Rúra 940 mm	Rúra 440 mm	Rúra 270 mm	Rúra nastaviteľná 530-880 mm	Rúra nastaviteľná 350-530 mm	Tlmič 940 mm	Koleno 45°	Koleno 30°	Koleno 90°	Koleno 90° s revíznym otvorom	T-kus 90°	T-kus 135°	Revízny T-KUS pre mokrú prevádzku	
80	* 47,28	* 29,10	* 24,67	* 59,60	* 46,87	* 86,55	* 36,81	* 42,18	* 74,66	* 105,63	* 62,36	* 105,02	100,48	
100	* 51,56	* 32,52	* 27,61	* 66,60	* 52,53	* 96,08	* 39,71	* 45,44	* 80,09	* 113,13	* 66,96	* 112,45	108,04	
130	56,66	34,90	29,09	71,61	55,01	99,02	38,24	44,20	80,29	114,72	66,64	114,00	106,29	
150	63,32	39,06	32,41	79,92	60,82	110,66	42,53	48,35	89,32	127,60	74,10	124,10	117,48	
180	70,79	44,20	37,40	88,23	68,29	124,10	48,35	56,66	101,55	145,07	103,17	135,74	156,73	
200	86,56	53,33	44,20	105,69	80,77	151,52	55,83	64,97	117,24	167,49	115,65	154,86	176,08	
250	110,66	64,15	54,16	132,42	98,19	193,89	67,46	76,61	141,68	202,39	140,73	253,05	212,77	
300	132,42	80,77	63,32	152,34	115,65	232,26	79,92	90,72	167,85	239,79	164,00	287,12	251,65	
350	149,99	81,81	70,06	184,71	133,75	308,85	117,31	124,93	246,36	351,95	278,81	335,44	422,34	
400	171,88	97,00	83,46	224,97	157,74	354,54	140,73	150,70	400,00	422,18	330,46	465,34	499,69	

* Priemery ø80 a ø100 dodávame aj s tesnením.

SK	KONTROLNÉ KUSY				UKONČENIA								
	056	052	060	061	010	011	015	013	014	017	018	019	
DN	Rúra s teplomerom	Revízny kus s dvierkami	Revízny uzáver	Revízny uzáver s odvodom kondenzátu	Hlavica proti dažďu	Ukončenie otvorené Izolované	Ukončenie otvorené horizontálne	Protidažďová manžeta	Stenové predĺženia	Prechod cez strechu 30°/45°	Prechod cez strechu 5°/30°	Prechod cez strechu 0/10°	
80	* 172,45	* 129,79	* 22,17	* 30,38	* 32,65	* 40,40	* 32,65	17,69	19,05	78,30	78,30	65,40	
100	* 175,90	* 138,88	* 24,08	* 32,84	* 34,82	* 43,08	* 34,82	18,86	20,31	83,54	83,54	69,76	
130	174,81	141,55	21,94	31,09	36,27	44,89	36,27	19,65	21,16	87,01	87,01	72,66	
150	178,95	144,88	23,79	32,92	42,44	48,20	43,20	21,16	21,91	87,01	87,01	72,66	
180	182,27	150,68	27,43	34,73	49,23	53,20	50,76	21,91	23,43	118,11	118,11	103,64	
200	207,34	169,81	31,09	40,23	57,55	68,16	64,35	25,69	28,72	118,11	118,11	103,64	
250	228,11	190,58	36,58	47,54	75,68	81,45	87,01	29,47	32,50	118,11	118,11	103,64	
300	240,58	204,71	45,71	54,84	92,30	98,34	111,19	32,50	37,92	213,42	168,71	155,13	
350	276,30	263,85	73,14	91,75	124,15	109,99	157,38	41,69	55,29	257,23	211,15	177,02	
400	308,85	303,04	85,93	104,54	158,89	136,59	195,28	48,47	62,83	300,43	248,91	220,97	

* Priemery ø80 a ø100 dodávame aj s tesnením.

* Priemery ø80 a ø100 dodávame aj s tesnením.

Geny sú v € bez DPH a dopravy.

DN 80 - 1000 mm

Jediná firma na trhu, ktorá ponúka certifikát CE až do priemeru Ø1000

Pri objednávke nad 100 € bez DPH doprava zdarma do 24 hodín !

Doručenie kuriérom Slovak Parcel Service (UPS) v nasledujúci pracovný deň v rámci celej SR.

ABC PLYN spol. s r.o., Československej armády 2, 036 01 Martin tel: 043-42 809 E-mail: info@abcplyn.sk www.abcplyn.sk

DVOJPLÁŠŤOVÝ IZOLOVANÝ SYSTÉM DINAK® DW 316L/304



OBJÍMKY A DRŽIAKY

SK	070	080	086	083	835	836	845	846	831	857	858	854	065
	Spojovacia objímka	Stenový držiak	Stenový držiak plochý	Stenový držiak nastaviteľný 70-120 mm	Stenový držiak nastaviteľný 100-250 mm	Stenový držiak nastaviteľný plochý 100-250 mm	Stenový držiak nastaviteľný 250-430 mm	Stenový držiak nastaviteľný plochý 250-430 mm	Nastaviteľná objímka 70-120 mm	Konzola	Konzoľová doska s odvodom kondenzátu	Rúra s konzoľovou doskou	Základová doska s odvodom kondenzátu
DN													
80	3,98	10,81	11,56	12,02	38,09	40,47	43,53	46,26	15,58	29,69	* 54,42	* 62,93	65,75
100	4,25	11,62	12,33	12,82	40,64	43,18	46,44	49,35	16,05	39,78	* 56,17	* 66,22	70,58
130	4,42	12,09	12,84	13,36	42,32	44,97	48,37	51,40	16,80	40,32	54,78	65,99	70,39
150	4,66	12,48	12,84	13,74	43,66	44,97	49,90	51,40	17,80	55,42	58,32	68,94	74,17
180	4,92	12,84	13,61	14,00	44,97	47,64	51,40	54,42	18,15	56,56	66,04	78,55	77,95
200	5,67	14,00	14,36	14,74	48,96	50,24	55,97	57,41	19,10	57,33	80,53	95,80	89,27
250	6,81	15,87	16,63	16,72	55,55	28,20	63,48	66,51	21,83	60,22	142,63	169,42	101,35
300	7,56	18,13	18,13	19,09	63,47	63,47	72,53	72,53	24,93	69,17	155,02	187,75	109,67
350	12,84	21,16	24,19		74,08	84,64	84,65	96,73	—	76,86	164,36	208,97	125,67
400	13,61	22,66	27,20		79,33	95,21	90,67	108,81	—	111,55	175,32	230,96	142,27

* Priemery ø80 a ø100 dodávame aj s tesnením.

OSTATNÉ KOMPONENTY

SK	110	100	120	026	105	106	001
	Uzemňovacia objímka	Adaptér kotla	Regulátor tahu	Redukcia	Prechod SW/DW	Prechod DW/SW	Tesnenie
DN							
80	10,89	26,35	69,86	54,15	15,16	38,53	2,41
100	11,62	28,55	74,95	58,19	17,63	41,53	3,00
130	12,09	26,59	74,94	57,49	18,89	40,14	3,60
150	12,09	28,26	75,78	64,15	21,71	41,51	3,60
180	12,84	31,59	79,92	72,46	25,96	43,05	4,81
200	13,61	37,40	86,56	83,25	28,80	50,26	5,41
250	15,12	46,69	99,86	101,53	37,30	59,09	6,61
300	16,63	58,32	113,16	119,80	50,89	70,68	7,21
350	22,66	61,65	138,24	176,04	72,70	75,04	7,82
400	24,94	74,10	164,82	193,89	83,09	83,10	8,42

STANOVENIE PRIEMEROV:

Priemer komína sa bežne stanoví v podmienkach podtlaku (prirodzený ťah) podľa normy Európskej únie EN 1856-1. Priemer komínových systémov pre mokrú prevádzku môžeme stanoviť aj v podmienkach pretlaku, ale len ak je maximálny pretlak v komíne 15 Pa.



* Priemery ø80 a ø100 dodávame aj s tesnením.

Ceny sú v € bez DPH a dopravy.

DN 80 - 1000 mm

Jediná firma na trhu, ktorá ponúka certifikát CE až do priemeru Ø1000

Pri objednávke nad 100 € bez DPH doprava zdarma do 24 hodín !



Doručenie kuriérom Slovak Parcel Service (UPS) v nasledujúci pracovný deň v rámci celej SR.

JEDNOPLÁŠŤOVÝ KOMÍNOVÝ SYSTÉM Z NEREZOVEJ OCELE S TESNENÍM

nový produkt navrhnutý výrobcom Dinak



BEZPEČNOSTNÉ UKONČENIE RÚRY
Zabrání poraneniu počas manipulácie s materiálom

 	
DINAK SW	
0036 CPD 90220 004	
Kominový	AISI 316L
EN 1856-1T160 P1 W V2 L50040 O(50)	EN 1856-1T160 P1 W Vm L20040 O(50)
EN 1856-1T250 N1 W V2 L50040 O(50)	EN 1856-1T250 N1 W Vm L20040 O(50)
0036 CPD 90220 020	
Kominové Vložky	AISI 316L
EN 1856-2T600 N1 W V2 L50040 G	EN 1856-2 T600 N1 W Vm L20040 G

Podľa predchádzajúcich pravidiel
sú k dispozícii rozsahy:
SW06 (hrúbka 0.6 mm)
SW08 (hrúbka 0.8 mm)

HLAVNÉ VLASTNOSTI

- Tesnosť spojov - tlaková trieda P1 (max. 200 Pa)
- Jednoduchá a rýchla montáž
- Prekrytie spojov: 50 mm
- Môže sa skracovať
- K dispozícii sú priemery od DN 80 - 600 mm
- Trojité tesnenie spojov: odolnosť voči teplote do 160°C

POUŽITIE

- Mokrú (M) alebo suchú (S) prevádzku komína
- Pretlakovú (P) alebo podtlakovú (N) prevádzku
- Ventilácia a odvod spalín
- Kondenzačné a turbo kotle

MATERIÁLY

- Nerezová oceľ AISI 304 (Trieda 1.4301), lesklé prevedenie
- Nerezová oceľ AISI 316L (Trieda 1.4404), lesklé prevedenie

ŠTANDARDNÁ HRÚBKVA

(iné hrúbky k dispozícii podľa predchádzajúcich pravidiel)

- Ø od 80 - 300 mm: 0,4 mm
- Ø od 350 - 450 mm: 0,5 mm
- Ø od 500 - 600 mm: 0,6 mm

PALIVÁ

- Plyn, olej
- Biomasa, drevo

PRACOVNÁ TEPLOTA

- 250°C: EN 1856-1: KOMÍNY
- 600°C: EN 1856-2: KOMÍNOVÉ VLOŽKY podtlakové bez tesnenia

RÚRY

020
Rúra
930 mm

025
Rúra
265 mm

203
Kotviaci diel
L = 930 mm
(pre q 80 -130 mm)

253
Kotviaci diel
L = 253 mm
(pre q od 130 mm)

022
023
Nastaviteľná rúra
022: L = 65 - 373 mm
023: L = 65 - 206 mm

024
Rúra
430 mm

001
Tesnenie

070
Spojovacia
objímka

KOLENÁ

044 Koleso 15°

Ø mm	80	100	110	120	130	140	150	160	180	200	250	300	350	400	450	500	550	600
A mm	20	20	20	25	25	25	25	25	30	30	35	35	50	50	55	60	65	65
A1 mm	70	75	75	75	75	75	75	80	80	80	85	90	100	105	110	110	115	120

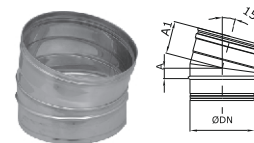

042 Koleso 30°

Ø mm	80	100	110	120	130	140	150	160	180	200	250	300	350	400	450	500	550	600
A mm	25	30	30	30	30	35	35	35	40	40	50	55	75	80	85	95	100	105
A1 mm	80	80	80	85	85	85	85	90	90	95	100	110	125	130	140	145	150	160

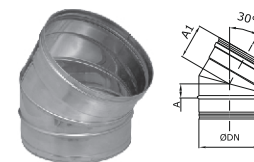

040 Koleso 45°

Ø mm	80	100	110	120	130	140	150	160	180	200	250	300	350	400	450	500	550	600
A mm	35	35	40	40	40	45	45	50	50	60	70	80	100	110	120	130	140	150
A1 mm	85	90	90	90	95	95	100	100	105	110	120	130	150	160	170	180	190	200

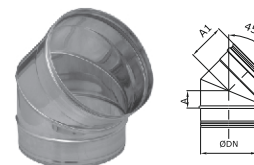

043 Koleso 87°

433 Koleso 90°

Ø mm	80	100	110	120	130	140	150	160	180	200	250	300	350	400	450	500	550	600
A mm	75	85	90	95	100	105	110	115	125	135	160	185	220	245	270	290	320	340
A1 mm	130	140	140	150	150	160	160	165	175	185	215	235	270	295	320	345	370	395
A mm	75	85	90	95	100	105	110	115	125	135	165	190	225	250	275	300	325	350
A1 mm	130	140	145	150	155	160	165	170	180	190	215	240	275	300	325	350	375	400

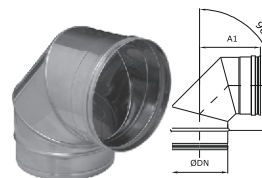

431
Koleso 87°
s revíznym
otvorom

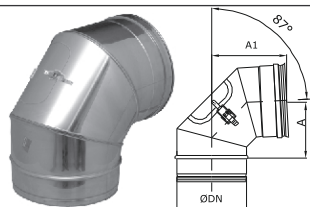

432
Koleso 90°
s revíznym
otvorom

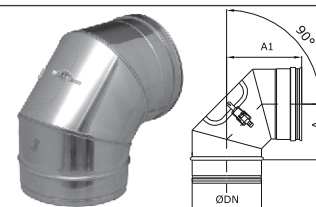

NEREZOVÝ KOMÍNOVÝ SYSTÉM SW

ABC PLYN

UKONČENIA

010 Hlavica proti dažďu

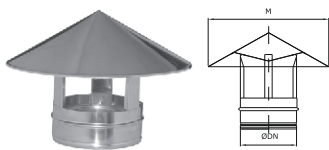

012 Hlavica proti vetru



011 Otvorené ukončenie

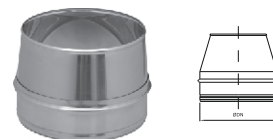

Ø mm	80	100	110	120	130	140	150	160	180	200	250	300	350	400
M mm	180	230	250	270	290	300	320	350	390	410	490	590	680	770

T- KUSY, REVÍZNE KUSY A ČISTIACE DVIERKA

031 T – kus 90°

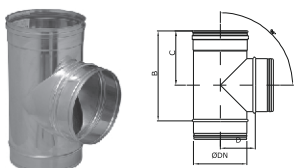

31B Redukčný T – kus 93°

(zistite dostupné priemery)

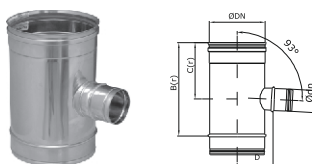

030

T – kus 135° pre mokrú alebo pretlakovú prevádzku

T – kus 135° pre suchú prevádzku alebo podtlakovú prevádzku

(zistite dostupné priemery)

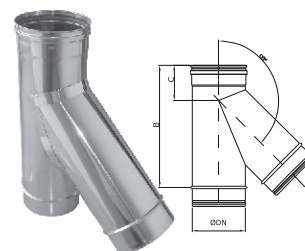

31A T – kus 93°

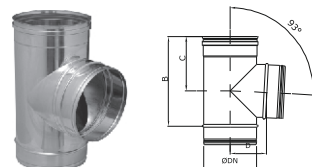

312 Redukčný T – kus 93°

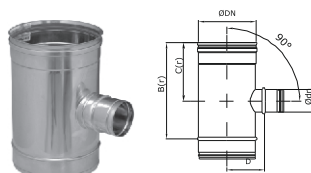

528

Revízny T – kus

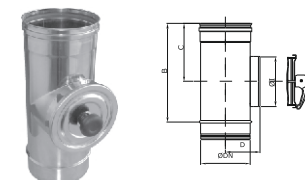

031 / 31A / 31B / 312

Ø mm	80	100	110	120	130	140	150	160	180	200	250	300	350	400	450	500	550	600
B mm	265	265	265	265	265	265	330	330	330	330	430	430	600	600	600	680	680	930
C mm	160	160	160	160	160	160	190	190	190	190	240	240	325	325	325	365	365	490
D mm	65	75	80	85	90	95	100	105	115	125	150	175	200	225	250	275	300	325

528

Ø mm	80	100	110	120	130	140	150	160	180	200	250	300	350	400	450	500	550	600
B mm	265	265	265	265	265	265	330	330	330	330	330	330	330	330	330	330	330	330
C mm	160	160	160	160	160	160	190	190	190	190	240	240	325	325	325	365	365	490
D mm	65	75	80	85	90	95	100	105	115	125	150	175	200	225	250	275	300	325
Ø mm	80	100	110	120	130	140	150	160	180	200	200	200	200	200	200	200	200	200

521 Revízny kus s dvierkami

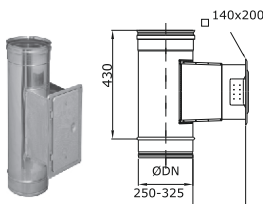

050 Rúra s meracím otvorom

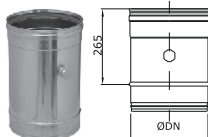

056 Rúra s teplomerom

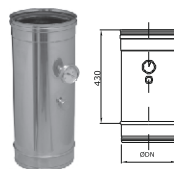

060 Uzáver revízny

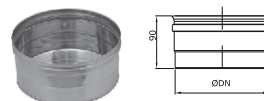

061 Uzáver revízny s odvodom kondenzátu

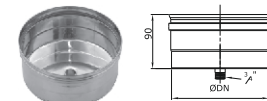

PRÍPOJKY

026 Redukcia

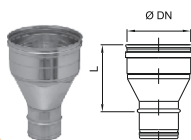

100 Adaptér spotrebiča

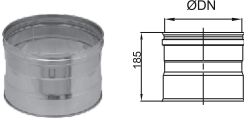

15P Prechod pre SW/DP

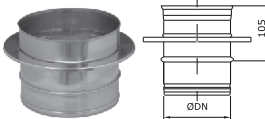

16P Prechod pre DP/SW

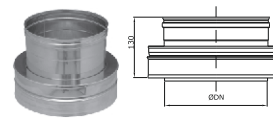

1C0 Adaptér kondenzačného kotla

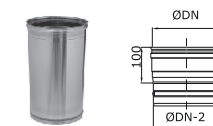

KRYTY

852

Krycia doska s protidažďovou manžetou



85c

Penová páska

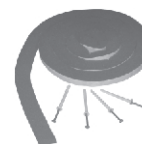

Ø mm	80	100	110	120	130	140	150	160	180	200	250	300	350	400	450	500	550	600
L mm	330	330	330	330	420	420	420	420	500	500	550	650	690	690	690	800	800	800

013

Protidažďová manžeta



014

Stenové komínové predĺženie

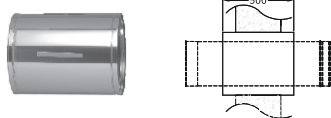

064

Protipožiarna doska



017

Prechod strechou - nastaviteľné lemovanie komína 30-45° s protidažďovou manžetou

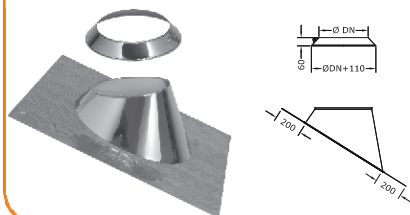

018

Prechod strechou - nastaviteľné lemovanie komína 5-30° s protidažďovou manžetou

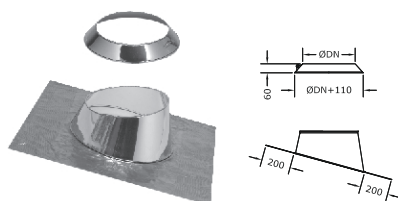

019

Prechod strechou - lemovanie komína 0° s protidažďovou manžetou

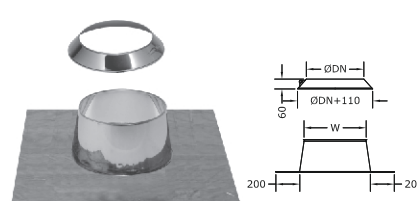

SPOJOVACIE OBJÍMKY A DRŽIAKY

086 Plochý stenový držiak

Ø mm	80	100	110	120	130	140	150	160	180	200	250	300	350	400	450	500	550	600
R mm	30	30	30	30	30	30	30	30	35	35	40	20	25	35	35	30	30	35
S mm	115	135	145	155	165	175	185	195	220	240	295	325	380	440	490	535	585	640
T mm	60	60	60	60	60	60	60	60	120	120	120	120	190	190	190	270	270	270

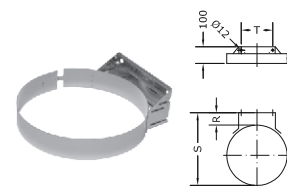

853 Konzola + rúra s konzolovou doskou

Ø mm	130	140	150	160	180	200	250	300	350	400	450	500	550	600
R1 mm	20-100	20-100	30-105	30-105	30-110	30-125	35-160	20-160	15-175	30-225	35-260	25-265	25-290	30-325

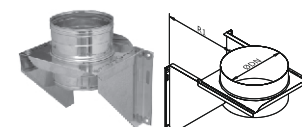

831

Nastaviteľný stenový držiak 70 - 120 mm

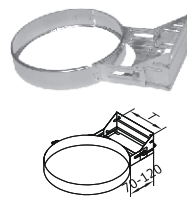

836

Nastaviteľný stenový držiak 100 - 250 mm

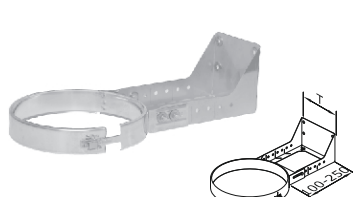

846

Nastaviteľný stenový držiak 240 - 460 mm

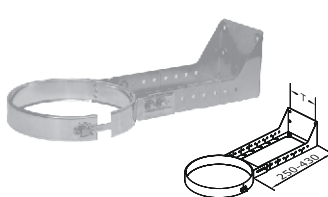

082

Strešný držiak

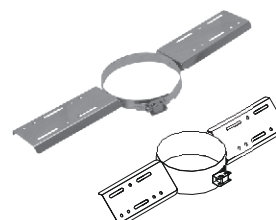

110

Uzemňovacia objímka

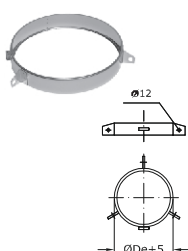

071

Dištančná objímka

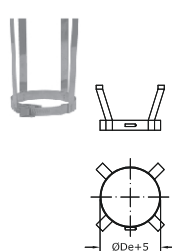

065

Základová doska s odvodom kondenzátu

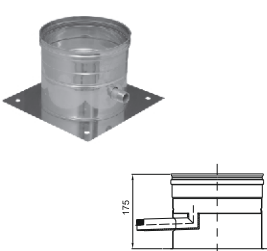

856

Nastaviteľný podlahový držiak

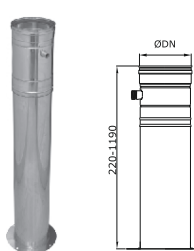

854

Rúra s konzolovou doskou

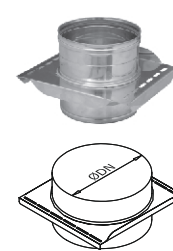

NEREZOVÝ KOMÍNOVÝ SYSTÉM SW

ABC PLYN

JEDNOPLÁŠŤOVÝ SYSTÉM DINAK® SW 316L/304



SK	RÚRY						KOLENÁ, T-KUSY					
	020	024	025	022	023	070	001	040	043	431	31A	312
DN	Rúra 930 mm	Rúra 430 mm	Rúra 265 mm	Rúra nastaviteľná 65 mm - 373 mm	Rúra nastaviteľná 65 mm - 206 mm	Objímka	Tesnenie	Kolienko 45°	Kolienko 87°	Kolienko 87° s revíznym otvorom	T-kus 93°	T-kus 90° redukčný
*80	16,54	10,59	8,33	18,05	13,77	2,41	2,30	11,26	15,57	18,23	20,26	
*100	19,23	12,40	9,80	20,99	16,03	2,41	2,87	13,21	17,85	20,85	23,40	33,66
110	17,94	10,46	7,60	19,87	14,44	2,72	3,44	11,08	16,16	19,40	24,12	36,19
120	19,27	11,22	8,15	21,32	15,49	2,72	3,44	11,58	17,12	20,54	25,66	38,50
130	21,11	12,30	8,94	23,37	16,99	3,02	4,60	12,07	17,99	21,59	29,25	43,88
140	22,71	13,22	9,61	25,11	18,27	3,02	5,17	12,80	19,10	22,92	31,32	46,97
150	24,28	14,14	10,28	26,86	19,54	3,02	6,32	13,52	20,20	24,24	33,36	50,05
160	26,66	15,52	11,29	29,48	21,45	3,17	6,89	15,19	22,96	27,56	35,93	53,90
180	29,03	16,91	12,30	32,12	23,37	3,32	7,47	16,86	25,72	30,86	38,50	57,75
200	32,19	18,75	13,63	35,63	25,89	3,32	8,04	19,11	28,43	34,11	46,20	69,29

SK	HLAVICE			T-KUSY, REVÍZNE A INÉ		
	010	012	011	528	521	065
DN	Proti dažďu	Proti vetru	Otvorené ukončenie	T-kus revízny	T-kus s revíznymi dvierkami	Doska základová s odvodom kondenzu
*80	23,74	34,95	18,91	37,01		
*100	25,51	37,55	18,70			
110	26,21	38,57	19,69			
120	28,93	42,57	20,86			
130	29,89	43,99	21,70			
140	31,76	46,74	22,82			
150	33,62	49,84	23,94	75,12	115,69	63,50
160	36,48	49,84	25,95		108,90	89,90
180	39,34	49,84	27,95	73,65	122,77	88,70
200	45,91	60,72	30,44	81,75	120,66	110,64

Certifikovaný produkt DINAK®

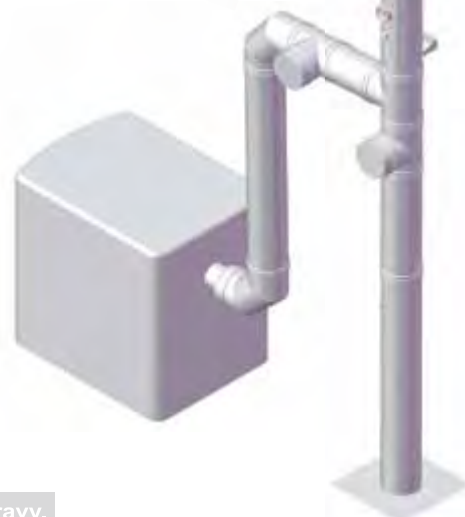

* Priemery ø80 a ø100 dodávame aj s tesnením. Ceny sú v € bez DPH a dopravy.

DN 80 - 1000 mm

Jediná firma na trhu, ktorá ponúka certifikát CE až do priemeru Ø1000

Pri objednávke nad 100 € bez DPH doprava zdarma do 24 hod. !

Doručenie kuriérom Slovak Parcel Service (UPS) v nasledujúci pracovný deň v rámci celej SR.

NEREZOVÝ KOMÍNOVÝ SYSTÉM SW

ABC PLYN

JEDNOPLÁŠŤOVÝ SYSTÉM DINAK® SW 316L/304



SK	UZÁVERY			REDUKCIE				UKONČENIE				
	060	061	613	026	100	15P	16P	017	018	019	013	014
DN	Uzáver revízny	Uzáver s odvodom kondenzu	Uzáver s odvodom kondenzu horizontál	Redukcia	Adaptér kotla	Redukcia SW/DW	Redukcia DW/SW	Prechod cez strechu 30° / 45°	Prechod cez strechu 5° / 30°	Prechod cez strechu 0°	Protidažďová manžeta	Stenové komínové predĺženie
*80	8,83	13,41	13,41	21,71	10,42	14,48	36,80	69,68	69,68	57,99	14,78	16,01
*100	10,91	14,83	---	25,15	12,19	16,84	39,67	72,36	72,36	60,22	15,35	16,63
110	8,87	12,52	---	24,44	10,22			75,04	75,04	62,46	15,91	17,25
120	8,90	12,92	---	26,24	10,98			77,72	77,72	64,68	16,48	17,86
130	9,08	13,60	18,02	28,76	12,03	18,04	38,34	81,66	81,66	67,96	17,32	18,77
140	9,64	14,03	---	30,92	12,93			82,02	82,02	68,33	17,61	19,13
150	10,20	14,46	20,00	33,08	13,83	20,74	39,65	82,39	82,39	68,69	17,91	19,49
160	11,09	15,58	---	36,31	15,18			82,75	82,75	69,05	18,48	19,85
180	11,97	16,70	22,12	39,55	16,53	24,80	41,13	83,12	83,12	69,41	19,06	20,21
200	13,32	17,71	23,45	43,85	18,34	27,51	48,01	83,12	83,12	69,41	21,95	20,93

SK	OBJÍMKY A INÉ ELEMENTY				
	086	831	836	846	082
DN	Plochý stenový držiak	Nastaviteľný stenový držiak 70 – 120 mm	Nastaviteľný stenový držiak 100 – 250 mm	Nastaviteľný stenový držiak 240 – 460 mm	Strešný držiak
*80	4,95	12,20	22,76	28,45	10,68
*100	5,08	12,38	23,33	29,16	14,39
110	5,20	12,55	23,89	29,87	---
120	5,32	12,73	24,46	30,58	---
130	5,56	13,08	25,59	31,98	11,56
140	5,68	13,26	26,11	32,64	---
150	5,79	13,43	26,63	33,29	11,90
160	7,69	24,48	35,35	44,19	15,69
180	9,58	35,53	44,06	55,08	23,00
200	10,02	36,74	46,09	57,60	24,80

SKUPINOVÉ MONTÁŽE (KASKÁDA)

Priemery určuje norma Európskej únie EN 13384-2. Podľa tohto štandardu sa priemery stanovujú vždy v podmienkach podtlaku, aby sa zabránilo prieniku spalínových plynov jedného z fungujúcich kotlov do kotlov, ktoré nie sú v prevádzke.

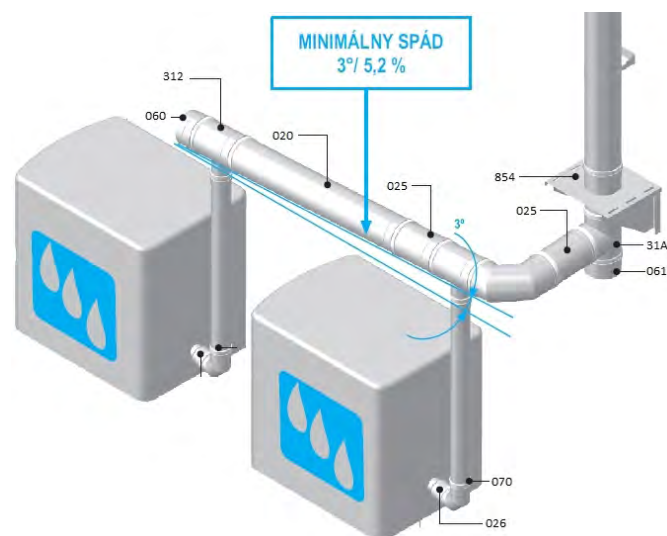

* Priemery ø80 a ø100 dodávame aj s tesnením. Ceny sú v € bez DPH a dopravy.

DN 80 - 1000 mm

Jediná firma na trhu, ktorá ponúka certifikát CE až do priemeru Ø1000

Pri objednávke nad 100 € bez DPH doprava zdarma do 24 hod. !

Doručenie kuriérom Slovak Parcel Service (UPS) v nasledujúci pracovný deň v rámci celej SR.

BERTRAMS SYSTÉM

Hrúbka: 2mm, plazmovo zvarané

Priemer: 120 až 250 mm

Tepelná odolnosť: max. 1000°C

Dĺžka: 250, 500, 1000 mm

Povrch: tepelne odolná čierna farba

Koleno nastaviteľné trojsegmentové 90°C



DN	kód	€
150	C0004	16,93
160	C0009	17,54

Komínová zder jednoduchá



DN	kód	€
150	C0016	5,66
160	C0015	6,00

Rúry DN 150 a 160



Rúry	DN	kód	€
1000	150	C0001	16,60
500	150	C0002	11,33
250	150	C0003	8,16
1000	160	C0005	17,54
500	160	C0006	11,56
250	160	C0008	8,44

Koleno univerzálne štvorsegmentové



DN	kód	€
150	C0028	22,89
160	C0029	23,09

OCEĽOVÉ POZINKOVANÉ DYMOVODY

FAL SYSTÉM

Hrúbka: 0,6 mm, plazmovo zvarané

Priemer: 100, 110, 120, 130 mm

Tepelná odolnosť: max. 400°C

Dĺžka: 250, 500, 1000 mm

EN 1856 - 2 T400 - N1 - D - Vm - L01060 - G(500)

Rúry DN 130



Rúry	DN	kód	€
1000	130	C0010	6,25
500	130	C0011	4,53
250	130	C0030	3,67

Koleno 90°



DN	kód	€
130	C0012	4,41

Komínová zder jednoduchá



DN	kód	€
130	C0031	2,46



Expanzomat 8L/10 BAR voda pitná



Kód	€
200127	32,50

Obehové čerpadlá Klasik



Typ	€
Čerpadlo 25/40 130 mm	54,00
Čerpadlo 25/40 180 mm	54,00
Čerpadlo 25/60 130 mm	57,00
Čerpadlo 25/60 180 mm	57,00
Čerpadlo 32/60 180 mm	76,00
Čerpadlo 32/80 180 mm	135,00
Čerpadlo omis 32/80 180 - šróbovacie	135,00

Obehové čerpadlá AUTO (úsporné)



Typ	€
Čerpadlo 25/40 130 mm AUTO	119,00
Čerpadlo 25/40 180 mm AUTO	119,00
Čerpadlo 25/60 130 mm AUTO	126,00
Čerpadlo 25/60 180 mm AUTO	126,00

Ponorné čerpadlá



Typ	€
Ponorné čerpadlo SKT 100	175,00
Ponorné čerpadlo SKT 150	219,00
Ponorné čerpadlo SKT 200	253,00
Ponorné čerpadlo SKM 100	179,00
Ponorné čerpadlo Omnitech 1100-5	200,00

Domové vodárne



Typ	€
Vodáreň JY 1000/24I/1100W/60I ^{min}	149,00
Vodáreň JY 1000/50I/1100W/60I ^{min}	165,00

Cirkulačné čerpadlo

Typ	€
Cirkulačné čerpadlo C.W.U. 1514	88,00



Zariadenie proti chodu čerpadla na sucho

Typ	€
Brio SK - 13 (proti chodu čerpadla na sucho)	33,00





Armatúry a filtračná technika

nemecká kvalita od SYR

* prevedenie so sedlom ventilu z ušľachtilej ocele

Membránový poistný ventil - mosadz



DN	bar	kód	€
DN15	6	2115.15.250	12,71
DN15	8	2115.15.251	12,71
DN15	10	2115.15.252	12,71
DN20	6	2115.20.250	19,49
DN20	8	2115.20.251	19,49
DN20	10	2115.20.252	19,49
DN25	6	2115.25.250	34,88
DN25	8	2115.25.251	34,88
DN25	10	2115.25.252	34,88
DN32	6	2115.32.250	84,09
DN32	8	2115.32.251	84,09
DN32	10	2115.32.252	84,09
DN40	6	2115.40.250	238,22
DN40	8	2115.40.251	238,22
DN40	10	2115.40.252	238,22
DN50	6	2115.50.250	269,91
DN50	8	2115.50.251	269,91
DN50	10	2115.50.252	269,91

Filter RATIO DFR so spät. preplachom a s red. ventilom



DN	kód	€
DN15	5315.15.004	87,21
DN20	5315.20.004	91,36
DN25	5315.25.004	97,51

Filter RATIO FR so spät. preplachom, bez red. ventilu



DN	kód	€
DN15	5315.15.005	59,98
DN20	5315.20.005	64,20
DN25	5315.25.005	70,17

Membránový poistný ventil priamy



DN	bar	kód	€
DN15	6	0034.15.011	14,92
DN15	8	0034.15.012	14,92
DN20	6	0034.20.006	16,20
DN20	8	0034.20.007	16,20

* pre elektrické zásobníky do 200 L

* integrovaná spätná klapka

Filter POU - pre jedno odberné miesto s preplachom s tromi stupňami filtrácie a s výtokovou armatúrou



DN	kód	€
DN20	7315.10.002	195,00



Závesné teplovzdušné generátory série MINIJET s axiálnym ventilátorom



Model	Príkon kW	Výkon kW	Kód	€
MJ20	17,3	16	3T5SKER015	1 900
MJ30	27,2	25	3T5SKER025	2 000
MJ40	36,7	34	3T5SKER035	2 100

Závesné teplovzdušné generátory série PA s axiálnym ventilátorom - jednostupňové prevedenie



Model	Príkon kW	Výkon kW	Kód	€
PA 16	15,0	13,8	3TASKER016	2 100
PA 26	25,4	23,0	3TASKER026	2 350
PA 36	33,8	30,5	3TASKER036	2 550
PA 46	46,3	41,7	3TASKER046	2 950
PA 66	65,0	58,6	3TASKER066	3 900
PA 86	85,0	76,6	3TASKER086	5 050
PA 106	104,7	94,3	3TASKER106	5 900

Závesné teplovodné ohrievače vzduchu AZN s priamym šírením vzduchu



Model	Výkon kW	Kód	€
AZN 12	13,3	3TZSKEC012	600
AZN 13	17,3	3TZSKEC013	640
AZN 23	23,8	3TZSKEC023	720
AZN 32	22,0	3TZSKEC032	740
AZN 33	28,5	3TZSKEC033	800
AZN 42	27,4	3TZSKEC042	820
AZN 43	35,4	3TZSKEC043	840
AZN 52	31,9	3TZSKEC052	880
AZN 53	42,7	3TZSKEC053	980
AZN 62	39,1	3TZSKEC062	1 000
AZN 72	47,4	3TZSKEC072	1 200
AZN 73	63,0	3TZSKEC073	1 320
AZN 82	67,7	3TZSKEC082	1 780
AZN 83	87,8	3TZSKEC083	1 920
AZN 92	88,8	3TZSKEC092	1 960
AZN 93	114,9	3TZSKEC093	2 880

*kompetný sortiment nájdete na stránke www.abcplyn.sk

Sústredný podtlak komína, ktorý umožňuje súčasne prívod vzduchu a odvod spalín, ktorý môže byť použitý na utesnenie miestnosti ventilátora odvodu kondenzačnými alebo nekondenzačnými spotrebičmi.



MATERIÁLY

Vonkajšia stena:

- AISI 304 (1.4301).
- AISI 316L (1.4404).
- Aluminizovaná oceľ (pre vnútorné inštalácie)

Vnútorná stena:

- AISI 304 (1.4301): nízko teplotné kotly.
- AISI 316L (1.4404): kondenzačné kotly.

KONEČNÁ ÚPRAVA

Lak (RAL rozsah)

PRACOVNÁ TEPLOTA

160° C

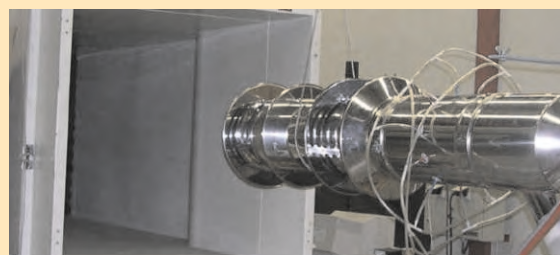

Analýza prietoku vzduchu DINAG zakončenia v GASTEC laboratóriu.

DINAG zakončenia boli testované v aerodynamickom tuneli v GASTEC laboratóriu (protokol o skúške Nw/wld/14E04/055) a spĺňajú navrhované kritéria BS 5440-1:2008, príloha F (predpísané), pre svorky systémového komína. Z hľadiska aerodynamických vlastností a percentuálnej recirkulácie.

Technické nákresy na kondenzačné a nízko teplotné kotly.

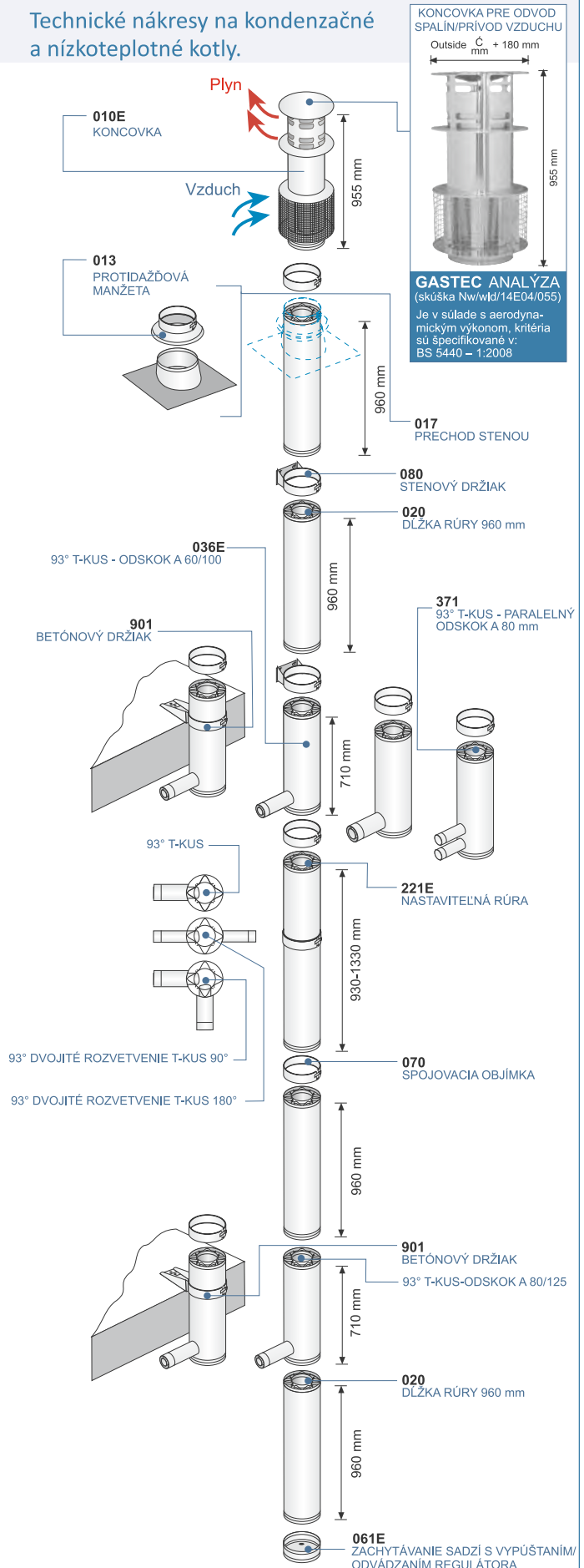

KOMPLETY PRE KOGENERAČNÉ ZARIADENIA

DINAK má celý rad produktov špeciálne navrhnutých na odvetrávanie spalín z elektrocentrál a generátorov.

ELEKTROCENTÁLY

Elektrocentrály vyprodukujú elektrickú energiu prostredníctvom alternátora, ktorý je zase poháňaný spalovacím motorom na benzín alebo naftu.

Odvádzanie dymových spalín vyprodukovaných generátorom je charakteristické nasledovnými faktormi:

- Vysoké teploty plynov od 400 to 600 °C.
- Vysoký podtlak dostupný na primárnom tlmiči v otvore, dosahuje až 5000 pa.
- Vysoká rýchlosť odvádzania plynov, od 25 až do 35 m/s.
- Problém s hlučnosťou vypúšťania je spôsobený zvukovou energiou skupiny a trením vysokorýchlostných plynov vo vnútri komína.
- Možnosťou tepelných dilatácií a vibrácií z generátora prenášaných do komína.
- Je potrebné izolovať požiarne úseky v budove, ak komín prechádza cez izolované časti v požiarne úseku.
- Nebezpečenstvo explózií pri spúšťaní a zastavovaní motora.

Prípady pre odovzdávanie dymových spalín z čerpadiel vykurovacích olejov sú podobné nastaveniam generátora, hoci majú menší rozsah výkonov a priemerov.

DINAK GE komín je navrhnutý pre činnosť vo vysoko tlakových podmienkach (H1) a vysokých teplotách plynu (T600, D), ktoré vytvárajú ideálne odovzdávanie spalín z takýchto zariadení.

Keď komín prechádza cez zóny požiarne úsekov využite DINAK EI potrebného rozsahu. Má rovnaké funkcie ako DINAK GE (T600,H1,D9), ale taktiež má EI 60 alebo EI 120 požiarne odolnosť. Pre vnútorné a vonkajšie požiare v oboch prípadoch platí (i↔o), v oboch vertikálnych aj horizontálnych zostaveniach zariadení.

Pre ďalšie informácie o DINAK EI sortimente sa informujte v konkrétnych technických a obchodných dokumentáciách.

VYBAVENIE PRE KOGENERÁCIU A MIKRO KOGENERÁCIU : DINAK hp

Kogeneračné zariadenie je založené na aktuálnej výrobe vhodného tepla a elektrickej energie a je v podstate vytvorený na základe generátora a výmenníka tepla.

Na rozdiel od zariadenia popísaného vyššie, teplota dymových spalín v tomto prípade je nízka, obvyčajne nižšia ako 200°C, čo znamená, že je tam nebezpečenstvo kondenzácie vo vnútri komína.

Za účelom odovzdávať dymové spaliny z kogeneračných a mikro kogeneračných zariadení, DINAK má svoju vlastnú hp radu komínov navrhnutých a vyrobených na činnosť vo vysoko tlakových podmienkach (H1) a nízkych teplotách plynu (T200,W).

Pre ďalšie informácie o DINAK EI sortimente sa informujte v konkrétnych technických a obchodných dokumentáciách.

GE

0036 CPD 90220 016



0036

DINAK GE37

EN 1856-1 T600 H1 D V2 L50040 O40
EN 1856-1 T600 H1 D Vm L20040 O40

DINAK GE50

EN 1856-1 T600 H1 D V2 L50040 O40
EN 1856-1 T600 H1 D Vm L20040 O40

DINAK GE100

EN 1856-1 T600 H1 D V2 L50040 O30
EN 1856-1 T600 H1 D Vm L20040 O30

CHARAKTERISTICKÉ INŠTALAČNÉ SCHÉMY

Ďalej v texte nájdete typickú inštalačnú schému pre DINAK GE sortiment s tromi možnosťami upevnenia pre vertikálnu časť komína.

Vo **Variante 1**, komín musí byť každé tri metre upevnený stenovými držiakmi do steny (080), ktoré sú umiestnené v kĺboch medzi prvkami, nahradzujúc spojovaciú objímku (070).

Vo **Variante 2**, je v hociktorom bode na komíne umiestnený plochý stenový držiak (086), a však vždy maximálny každé 3 metre, zaručujúc horizontálnu stabilitu, ale nie je stavaný aby niesol akúkoľvek záťaž. Konzolová doska (853 alebo 085) je umiestnená na podstavci, ktorý nesie záťaž.

Vo **Variante 3** je rozdiel od Varianty 2, kde T kus je umiestnený nad konzolovou doskou (853 alebo 085). V prípade maximálnej záťaže na T kus musí byť skontrolovaný, aby udržal celú vertikálnu váhu.

DINAK GE musí byť upevnený od pevného bodu rozťažnosti a bez vibrácií.

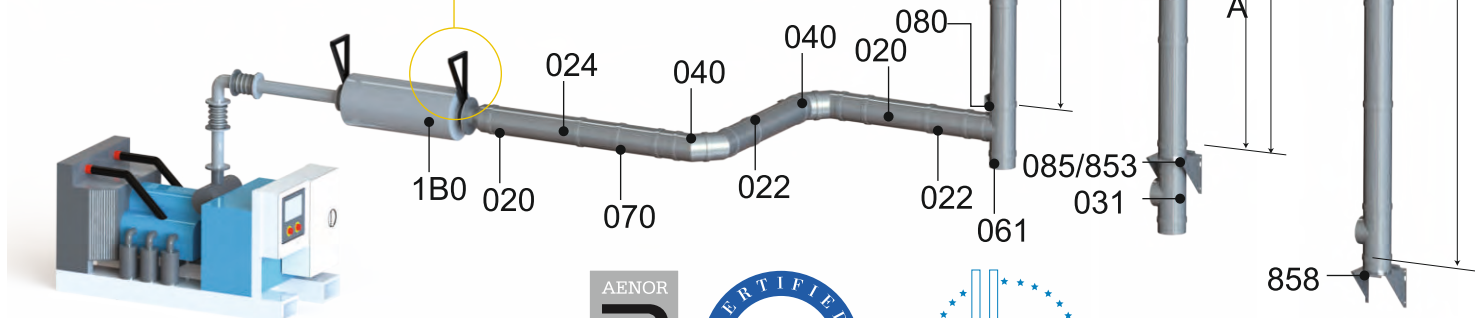

ABC PLYN

Komínové systémy

Kontaktné informácie:

ABC PLYN, spol.s r.o.

Československej armády 2
036 01 Martin
Slovakia

Tel.: 043 - 42 24 809

Fax: 043 - 43 01 888

E-mail: info@abcplyn.sk

IČO: 36408689

IČ DPH: SK 2020123380

Internet: www.abcplyn.sk

